

AperTO - Archivio Istituzionale Open Access dell'Università di Torino

**Mixed lineage kinase MLK4 is activated in colorectal cancers where it synergistically cooperates with activated RAS signaling in driving tumorigenesis**

**This is the author's manuscript**

*Original Citation:*

*Availability:*

This version is available <http://hdl.handle.net/2318/131744> since

*Published version:*

DOI:10.1158/0008-5472.CAN-12-3074

*Terms of use:*

Open Access

Anyone can freely access the full text of works made available as "Open Access". Works made available under a Creative Commons license can be used according to the terms and conditions of said license. Use of all other works requires consent of the right holder (author or publisher) if not exempted from copyright protection by the applicable law.

(Article begins on next page)



UNIVERSITÀ DEGLI STUDI DI TORINO

This is an author version of the contribution published on:

M. Martini, M. Russo, S. Lamba, E. Vitiello, E. H. Crowley, F. Sassi, D.  
Romanelli, M. Frattini, A. Marchetti, A. Bardelli

Mixed lineage kinase MLK4 is activated in colorectal cancers where it  
synergistically cooperates with activated RAS signaling in driving  
tumorigenesis

CANCER RESEARCH (2013) 73

DOI: 10.1158/0008-5472.CAN-12-3074

The definitive version is available at:

<http://cancerres.aacrjournals.org/cgi/doi/10.1158/0008-5472.CAN-12-3074>

**Mixed lineage kinase 4 (MLK4) is mutationally activated in colorectal cancers  
and its inactivation impairs the growth of RAS-driven tumors**

Miriam Martini<sup>1\*</sup>, Mariangela Russo<sup>1\*</sup>, Simona Lamba<sup>1</sup>, Elisa Vitiello<sup>1</sup>, Francesco Sassi<sup>1</sup>, Davide Romanelli<sup>2</sup>, Milo Frattini<sup>2</sup>, Antonio Marchetti<sup>3</sup> and Alberto Bardelli<sup>1,4#</sup>

<sup>1</sup>Laboratory of Molecular Genetics, Institute for Cancer Research and Treatment, University of Torino Medical School, University of Torino Medical School, Strada Provinciale 142 Km 3.95; Candiolo (TO); ZIP 10060, Italy;<sup>2</sup>Laboratory of Molecular Diagnostic, Institute of Pathology Via in Selva, 24, 6600 Locarno, Switzerland;  
<sup>3</sup>Clinical Research Center, Center of Excellence on Aging, University-Foundation, Chieti, Italy; <sup>4</sup>FIRC Institute of Molecular Oncology, Via Adamello 16, Milan, ZIP 20139, Italy.<sup>#</sup>

Correspondence to:

Alberto Bardelli PhD

Laboratory of Molecular Genetics, Institute for Cancer Research and Treatment,  
University of Torino; Medical School

Str prov 142 Km 3.95; Candiolo (TO); ZIP10060, Italy

Email: [alberto.bardelli@unito.it](mailto:alberto.bardelli@unito.it)

Tel: ++39 011 993.3235

\*These authors contributed equally to this work.

**Running title**

MLK4 mutations and KRAS driven colorectal cancer.

**Key words**

Kinase, mutations, metastatic colorectal cancer, KRAS

**Abstract**

CRCs are commonly classified into those with microsatellite instability (MSI) and those that are microsatellite stable (MSS) but chromosomally unstable. The latter are characterized by poor prognosis and remain largely intractable at the metastatic stage. Comprehensive mutational analyses have revealed that the most frequently mutated protein kinase in microsatellite stable CRC is *Mixed Lineage Kinase 4* (MLK4). This kinase has not been characterized previously and the relevance of MLK4 somatic mutations in oncogenesis has not been established. We report that MLK4 mutated alleles are constitutively active and increase the transformation and tumorigenic capacity of RAS mutated cell lines. Gene expression silencing or targeted knockout of the MLK4 gene impairs the oncogenic properties of KRAS and BRAF mutant cancer cells both *in vitro* and *in vivo*. In establishing the role of MLK4 in intracellular signaling we show it directly phosphorylates MEK1 and that MEK/ERK signaling is impaired in MLK4 knock out cells. These findings suggest that MLK4 inhibitors may be efficacious in KRAS and BRAF mutated colorectal cancers and may provide a new opportunity for targeting such recalcitrant tumors.

## Introduction

The genomic landscape of cancers is highly complex with perhaps the most striking feature being the frequency of previously uncharacterized mutations. What is now acutely required is to define those mutations that play a directive role in tumorigenesis and those that inherently accumulate as a consequence of genetic instability. Such genetic lesions can be categorized as driver and passenger or “hitchhiker” mutations, respectively. Establishing whether the mutations are fundamental drivers of disease progression or not will enable us not only to understand the basic mechanisms of tumorigenesis and the significance of their acquisition to disease progression, but may provide additional therapeutic avenues. This is exemplified by the identification of mutations in kinases such as ALK, HER2, AKT1, MEK1 and MET in lung cancer proving that genetic lesions that direct pathogenesis can be successfully exploited for cancer treatment (1). Unfortunately, despite the potential clinical relevance of such novel cancer alleles, their rate of discovery far outstrips their rate of functional validation.

*Mixed Lineage Kinase 4* (MLK4) is the most frequently mutated protein kinase in microsatellite stable CRCs (2, 3). The latter encompass the vast majority of sporadic CRC and are characterized, as compared to MSI tumor, by poorer prognosis (4).

MLKs are a family of serine-threonine kinases thought to control multiple intracellular signaling pathways (5-7). MLKs are characterized by an amino-

terminal SRC-homology domain (SH3) (8) followed sequentially by a kinase domain, a leucine-zipper region and a Cdc42/Rac Interactive Binding (CRIB) motif. The carboxyl terminus of all MLKs is proline-rich but diverges significantly among different members of the family, suggesting that this region serves different regulatory functions (9, 10).

Systematic genomic analyses led to discovery that *MLK4* is mutated in gliomas and CRCs suggesting that this kinase plays an important role in tumorigenesis (2) (3). As nothing is presently known about the biochemical and cellular properties of wild type and mutant *MLK4*, we analyzed its role in neoplastic cells using forward and reverse genetics as well as biological and biochemical assays.

## **Materials and Methods**

### *Mutational Analysis*

PCR primers were designed using Primer 3 ([http://frodo.wi.mit.edu/cgi-bin/primer3/primer3\\_www.cgi](http://frodo.wi.mit.edu/cgi-bin/primer3/primer3_www.cgi)), and synthesized by Invitrogen/Life Technologies, Inc. (Paisley, England). The PCR and sequencing primers are listed in Supplementary Table 2. PCR primers that amplify the selected exons and the flanking intronic sequences, including splicing donor and acceptor regions, were used and PCR products were on average 381 bps in length. PCRs were performed in both 384- and 96-well formats in 5- or 10- $\mu$ L reaction volumes, respectively, containing 0.25 mmol/L deoxynucleotide triphosphates, 1  $\mu$ mol/L each of the forward and reverse primers, 6% DMSO, 1 $\times$  PCR buffer, 1 ng/ $\mu$ L DNA, and 0.05 unit/ $\mu$ L Platinum Taq (Invitrogen/Life Technologies). A touchdown PCR program was used for PCR amplification (PeltierThermocycler, PTC-200, MJ Research, Bio-Rad Laboratories, Inc., Italy). PCR conditions were as follows: 94°C for 2 min; three cycles of 94°C for 15 s, 64°C for 30 s, 70°C for 30 s; three cycles of 94°C for 15 s, 61°C for 30 s, 70°C for 30 s; three cycles of 94°C for 15 s, 58°C for 30 s, 70°C for 30 s; and 35 cycles of 94°C for 15 s, 57°C for 30 s, and 70°C for 30 s, followed by 70°C for 5 min and 12°C thereafter. PCR products were purified using AMPure (Agencourt Bioscience Corp., Beckman Coulter S.p.A, Milan, Italy). Cycle sequencing was carried out using BigDye Terminator v3.1 Cycle Sequencing kit (Applied Biosystems, Foster City, CA) with an initial denaturation at 97°C for 3 min, followed by 28 cycles of 97°C for 10 s, 50°C for 20 s, and 60°C for 2 min. Sequencing products were purified using CleanSeq (Agencourt Bioscience,

Beckman Coulter) and analyzed on a 3730 DNA Analyzer, ABI capillary electrophoresis system (Applied Biosystems). Sequence traces were analyzed using the Mutation Surveyor software package (SoftGenetics, State College, PA). For samples in which mutations were found, matching between germline and tumor DNA was verified ascertain that mutations found were somatic.

#### *DNA Constructs and Mutagenesis*

Full-length MLK4 cDNA was subcloned into the pCEV29.1 (11) or into pRRL plasmid (12). Mutants of MLK4 containing point mutations were constructed using the QuikChange II XL Site-directed mutagenesis kit (Stratagene) with MLK4 wt plasmid as the template DNA. The presence of the appropriate mutations was confirmed by DNA sequencing. The constitutively active KRAS expression vector used was pDCR-H-RasV12, kindly provided by Letizia Lanzetti (Torino Medical School, Candiolo, Torino, Italy)

#### *Antibodies*

MLK4 specific antibodies were developed using a standard immunization protocol (two rabbits immunized for each epitope), we generated polyclonal antisera and antibodies directed against either the N- or the C-terminus of MLK4 (Biogenes). The primary antibodies used for immunoblotting were: anti-Vinculin (Sigma-Aldrich), anti-GST, anti-P-MEK1/2 (Ser217/221), anti-MEK1/2, anti-P-ERK1/2 (Thr202/Tyr204), anti-ERK1/2, anti-P-SAPK/JNK (Thr183/Tyr185), anti-SAPK/JNK,



anti-P-AKT (Ser473), anti-AKT, anti-P-EGFR (Y845), anti-P-EGFR (Y1068) and anti-EGFR, (Cell Signaling), anti-E-cadherin (R&D).

#### *Cell culture*

A-549, 293T, SW48, NIH3T3 and LoVo were obtained in 2005 from American Type Culture Collection (ATCC; Manassas, VA) which performs routine cell line authentication testing by SNP and STR analysis. HCT116, Colo205 and DLD1 were obtained in 2005 from NCI60 cell line panel (Wellcome Trust Sanger Institute). DiFi were provided in 2005 by Prof. Baselga (Vall d'Hebron University Hospital, Barcelona). All the cell lines were tested by SNP and STR analysis (Cell ID™ System from Promega) to confirm their authenticity in last 12 months.

A-549, Colo205 and HCT116 were cultured in RPMI-1640 medium (Invitrogen); 293T, SW48, NIH3T3 and DLD1 were grown in DMEM (Invitrogen); DiFi and LoVo were cultured in F12 medium (Invitrogen).

#### *Transfections and transformation assays*

NIH3T3 fibroblasts were seeded at  $2 \times 10^5$  cells in 100mm plate and grown for 24 h before transfection using high-efficiency liposome transfection method (Lipofectamine 2000 and Plus Reagent; Invitrogen). Each plate was transfected with 4 µg of the pCEV29.1 vector containing either no insert or a cDNA encoding for a MLK4 protein (wild-type or mutant). For co-operation experiments, cells were transiently co-transfected with 0.1µg of RasV12 plasmid and 4µg of pCEV

containing the different MLK4 wt and mutants. Foci were scored two weeks after transfection following fixation with glutaraldehyde 11% and Giemsa staining.

#### *Protein analysis*

Total cellular proteins were extracted by solubilizing the cells in boiling SDS buffer (50 mM Tris-HCl, pH 7.5, 150 mM NaCl, and 1% SDS). WB detection was done by enhanced chemiluminescence (GE Healthcare). For immunoprecipitations, cells were lysed at 4°C with buffer containing 20 mM Tris-HCl [pH 7.4], 150 mM NaCl, 10% glycerol, and 1% Triton X-100 in the presence of protease and phosphatase inhibitors (1 mM Na<sub>3</sub>VO<sub>4</sub>, 100 mM NaF, 1 mM PMSF, 10 µg/ml leupeptin, 10 µg/ml aprotinin, and 1 µg/ml pepstatin). Extracts were incubated with primary antibody ON at +4°C.

#### *Kinase assays*

Immunoprecipitated MLK4 (using anti-N end MLK4 Ab) was washed in kinase buffer (Hepes-NaOH, pH 7.5 60mM, MgCl<sub>2</sub> 3 mM, MnCl<sub>2</sub> 3 mM, Na-orthovanadate 3 µM, DTT 1.2 mM, PEG8000 100 µg/ml) and resuspended in 30 µl of kinase buffer. Kinase reaction was performed at RT adding 1 µM cold ATP and 100 ng of Myelin Basic Protein (MBP) (Sigma Aldrich). Activity was assessed by ATP content using the CellTiter-Glo® Luminescent Assay (Promega). Samples developed luminescence was recorded using DTX880 Multimode Detector (Beckman Coulter, Milano). For MEK kinase assay, 100 ng of recombinant MLK4 (Prokinase) were incubated with 1 µg of MEK1 K97M (Prokinase) or ERK2 K54R

(Proqinase) in kinase buffer. Kinase reaction was performed at 22°C RT adding 1μM ultra-pure ATP (Promega). Activity was assessed either by ATP content using the ADP-Glo® Luminescent Assay (Promega). Samples developed luminescence was recorded using DTX880 Multimode Detector (Beckman Coulter, Milano).

#### *Suppression of gene expression by RNAi*

MLK4 expression was suppressed in tumor cells by lentiviral-mediated expression of shRNAs(Sigma) specifically targeting the MLK4 transcript. To rule out the variability of biological responses, we used four different shRNA directed against MLK4 sequence. All sequences were able to suppress MLK4 expression although at different levels while control Sh (CTRL) was not. The two most efficient shRNA, among the different recipient cell lines, were then selected for the subsequent experiments.

#### *Targeted deletion of the MLK4 locus in human cancer cells*

Disruption of the MLK4 exon 1 in the CRC HCT116 cells was performed as previously described (13). Clones were selected after 2 weeks of growth under 0.4 mg/ml for HCT116 cells geneticin (Invitrogen, Carlsbad, CA) selection and then propagated in the absence of selective agents. Homologous recombination events were identified by locus-specific PCR screening.

#### *Anchorage-independent growth assays*

Cells were diluted to a concentration of 500-1000 cells/ml in appropriate medium containing 5% FBS, 0.5% Seaplaque agar. Cells were seeded in 24-well plates (1 ml/well) containing a 1 % agar underlay and supplemented three times a week with corresponding medium. Colonies were scanned and scored two weeks after seeding.

#### *Proliferation assays*

Parental and knockout or knockdown cells were seeded in 200 µl of 5% FBS growth medium at appropriate density in 96-well plastic culture or ultra-low attachment plates. Plates were incubated at 37 °C in 5% CO<sub>2</sub> for a total of 7 days. Cell viability was assessed every 24h by ATP content using the CellTiter-Glo Luminescent Assay (Promega). All luminescence measurements were recorded by the DTX 880-Multimode plate reader (Beckman–Coulter).

#### *Animal studies*

All animal procedures were approved by the Ethical Commission of the University of Turin and by the Italian Ministry of Health. Six-week-old immunocompromised CD1<sup>-/-</sup> nude athymic female mice (Charles River Laboratories, Lecco, Italy) were injected subcutaneously in right posterior flanks. Tumor appearance was evaluated every 2d using a caliper. Tumor volume was calculated using the formula  $V = 4/3 \times (d/2)^2 \times (D/2)$ , where d is the minor tumor axis and D is the major tumor axis. Superficial pulmonary metastases were contrasted by black India ink airway

infusion before excision, and were counted on dissected lung lobes under a stereoscopic microscope.

## RESULTS

### ***MLK4 is mutated in colorectal cancers and glioblastomas***

Others and we previously reported the identification of somatic mutations in the *MLK4* gene in colorectal tumors (CRCs) (2) (3). We extended the mutational profiling of the coding region of the *MLK4* gene in additional tumor types including bladder, breast, gastric, glioma, melanoma, lung, pancreas and ovary (Supplementary Tables 1 and 2). We further established the prevalence of *MLK4* mutations in a large CRC dataset (340 samples). In addition to those previously reported we found new somatic mutations affecting the *MLK4* gene in CRCs and GBMs (Table 1). Some of the mutations had not been previously reported (S322P, R442Q, K494Q), some were found in independent samples (P843S), other were closely located to those previously found (R553STP) and other were identical to those that were previously identified (R470C) (Figure 1A). Some residues (for example R470) were affected multiple times. Overall the *MLK4* mutation frequency is 3% (9/340) and 2% (2/113) in CRCs and GBMs respectively.

We next determined whether the *MLK4* mutations can co-occur with mutated *KRAS* or *BRAF* oncogenes, two major oncogenic players in colorectal cancer. To this end we assessed the *KRAS* and *BRAF* mutational status in the entire set of CRCs and GBMs. We found 2 cases *KRAS/MLK4* positive, 2 cases *BRAF/MLK4* positive and 7 cases in which *MLK4* mutations occur alone (Table 1). We

concluded that MLK4 mutations can occur both independently but also together with KRAS or BRAF mutations.

### ***Mutant MLK4 cooperates with Ras in driving cell transformation***

Next, we sought to establish the role of MLK4 mutations on cellular phenotypes associated with tumorigenesis using both forward and reverse genetic strategies. We initially used the standard NIH3T3 focus forming assay to assess the transforming potential of wt and mutated *MLK4* alleles. A kinase-inactive MLK4 mutant, K151A, was used as control. Neither wild type nor mutant MLK4 triggered focus formation, while as expected, *RAS* G12V readily transformed NIH3T3 cells (Figure 1B). This indicates that wt and mutant *MLK4* alleles are unable, *per se*, to sustain full cellular transformation. Given the co-occurrence of MLK4 mutations with KRAS and BRAF in CRCs, we assessed whether mutant MLK4 may cooperate with oncogenic *RAS* (G12V). A striking synergistic effect was observed (Figure 1C). Importantly, while MLK4 mutant increased the transforming potential of *RAS* G12V, the wild type and the kinase dead did not.

### ***MLK4 mutants display increased kinase activity***

To assess whether the mutations were activating in nature, we measured how they affected the kinase activity of the MLK4 protein. A mutation at position H261 was selected for subsequent studies as it is located in a region (HRDLK) highly conserved among MAP kinases and it was observed to be mutated twice (H261Y and H261Q). The G291E mutation was chosen as it is located in a region

corresponding to the BRAF V600E oncogenic mutation found in multiple tumor types (14). R470C was characterized as this variant has been identified in two independent CRC samples. Finally, the R555STP change was selected to investigate the impact of a truncating mutation on the catalytic activity of MLK4. Lentiviral vectors were designed to transiently stably express *MLK4* wt and corresponding mutant alleles (H261Y, G291E, R470C and R555STP) (Figure 2A). In order to compare the enzymatic activity of wt and mutated MLK4 proteins we used an *in vitro* biochemical assay. The recipient cells used for these experiments was a colorectal cancer cell line in which the MLK4 gene was genetically inactivated, in order to dissect the activity of transduced proteins in the absence of the endogenous MLK4 protein (see paragraphs below and Figure 3B for full details on the MLK4 knock-out cells). The kinase activity of wt and mutant MLK4 proteins was measured using a luminescent kinase assay. Mutated MLK4 proteins displayed increased kinase activity, albeit at different levels, as compared to wt (Figure 2B). These results indicate that the MLK4 mutations identified in previous analysis are indeed activating.

***Expression of mutant MLK4 enhances the tumorigenicity of cancer cell lines in vivo***

We next assessed the oncogenic potential of mutated MLK4 in the neoplastic process. We checked whether ectopic expression of wt or mutated MLK4 affected the tumorigenic properties of DLD1, a KRAS mutant colorectal cancer cell line. DLD1 cells expressing wt MLK4, G291E or R470C mutants were subcutaneously



injected in immunocompromised mice. Cells expressing the empty vector were used as controls. DLD1 cells transduced with mutant MLK4 gave rise to larger tumors compared to control cells (Figure 2C). We then extended the experiments to another tumor type, the lung cancer cell line A549 which also bears a KRAS mutation. Results were comparable to those obtained with the DLD1 colorectal cancer cell lines (Supplementary Fig. 1A). Metastasis formation in the lungs of mice bearing MLK4 over-expressing tumors was next quantified. We found that the number of metastases was increased in MLK4 mutant expressing tumors versus controls in both DLD1 (Figure 2D) and A549 (Supplementary Fig. 1B) cellular models. Altogether these observations support a role for MLK4 mutations in increasing the tumorigenicity of cancer cells carrying KRAS mutations.

#### ***Generation of knock down and knock out cellular models of MLK4***

As a complementary approach, reverse genetics was used to evaluate how reduced expression or deletion of the *MLK4* gene affected the tumorigenic properties of cancer cells. We first identified shRNA that efficiently targeted the *MLK4* sequence leading to effective and stable down-regulation of its expression. Two independent MLK4 shRNAs were selected based on their ability to reduce MLK4 expression in multiple cell lines derived from colon and lung cancers (Figure 3A).

To exclude potential off-target effects of the shRNA approach, we also established an isogenic cell line in which the MLK4 gene was disrupted and hence not expressed. The colorectal cancer cell line HCT116 was selected for gene targeting

as it contains a KRAS mutation. Furthermore, this cell line is diploid at the MLK4 locus and is amenable to gene targeting through homologous recombination (15). AAV-mediated homologous recombination was exploited to delete the first exon of MLK4, which encodes the kinase domain (Figure 3B). A two-step genetic strategy was used to obtain first heterozygous and then homozygous HCT116 cells in which both alleles of the *MLK4* locus were targeted. Two independent MLK4 *-/-* clones (HCT116 MLK4 *-/-* a and HCT116 MLK4 *-/-* b) were identified by polymerase chain reaction (PCR) using primers specific to the targeting vector and to adjacent genomic sequences. Targeted (knock-out) cells were viable yet lacked MLK4 expression as confirmed by immunoblotting with the anti-MLK4 antibody (Figure 3C).

***Gene expression silencing or genetic inactivation of MLK4 impairs the tumorigenic properties of cancer cells***

We initially investigated the effect of transcriptional down-regulation of MLK4 on anchorage-independent growth, a key feature of the neoplastic phenotype. As a model system, we used multiple cancer cell lines. The panel included cell lines either wild type or carrying mutations in KRAS or its effector BRAF. In two cell models, SW48 and DiFi, both wild type for KRAS and BRAF, the reduction of MLK4 expression exerted limited or no effect. When MLK4 expression was knocked down in cancer cells carrying activating mutations in KRAS or BRAF (A549, Colo-205, DLD1 and HCT116) anchorage-independent growth was

markedly affected. In the HCT116 cell line growth was almost completely impaired (Figure 4A). To further assess the effect of MLK4 on cell growth, we investigated proliferation rates in tissue culture plates and in soft agar. MLK4  $-/-$  clones grew at lower rate than wt cells on plastic (Supplementary Fig. 2A) and this difference was also observed when the cells were assessed for anchorage independence (Figure 4A). To provide further evidences of the role of mutated MLK4 in the growth of colorectal cancer cells, we evaluated the effects of MLK4 downregulation in an additional CRC cell line (LoVo) which we found to carry one of the MLK4 heterozygous mutation (R470C) increasing the MLK4 transforming potential (Supplementary Fig. 2B). MLK4 knock down reduced the growth rate of LoVo cells on plastic (Supplementary Fig. 2C) and this difference was even more evident when the assay was performed in low adherence or in anchorage-independent conditions (Supplementary Fig. 2D-E).

Next, we determined the effect of reduced or abrogated MLK4 expression on the tumor forming ability of colorectal cancer cells *in vivo*. To this end we took advantage of two cellular models: DLD1 and HCT116. In DLD1 MLK4 expression was down-regulated by shRNA, in HCT116 it was ablated by genetic targeting of the MLK4 locus. The cells and their parental controls were injected into immunocompromised mice. DLD1 cells rapidly formed tumors whilst tumor formation in MLK4 knock-down DLD1 cells was significantly delayed (Figure 4B). Most notably, HCT116 cells lacking MLK4 expression were virtually unable to form

subcutaneous tumors while the corresponding isogenic wt cells rapidly grew forming large tumor masses (Figure 4C).

### ***MLK4 phosphorylates MEK1 on Ser217/221***

The data presented above suggest that MLK4 acts within the KRAS/MAPK pathway, we therefore hypothesized that MLK4 may turn on (directly or indirectly) MEK or ERK, two MAP kinases activated by phosphorylation. The kinase domain of MLK4 (aa A98 to L451) was expressed as a GST fusion protein in insect cells using the baculovirus system and purified. We then assessed whether the MLK4 protein could directly phosphorylate MEK1 and ERK2. Considering that the latter are also kinases, we used their catalytically inactive versions in which the lysine which coordinates ATP-binding is mutated (MEK1-K97M and ERK2-K54R). We found that MEK1 but not ERK2 were readily phosphorylated by MLK4 (Figure 5A). To assess which residue of MEK1 was phosphorylated by MLK4 we performed western immunoblotting with anti-MEK1 phospho-specific antibodies. These experiments showed that MEK1 is phosphorylated by MLK4 on Ser217/221 (Figure 5B). Overall, the *in vitro* phosphorylation experiments are consistent with a role of MLK4 as a MEK (or MAP3) kinase and we propose that MLK4 modulates this pathway by direct phosphorylation of MEK which, in turn, activates ERK.

### ***MLK4 modulates MEK/ERK signaling in cancer cells***

We then sought to better define the role of MLK4 in the MEK/ERK signaling pathway. Ligand-mediated activation of receptor tyrosine kinases is considered the

initial event in this pathway. We focused on the Epidermal Growth Factor receptor (EGFR) tyrosine kinase, a well characterized receptor implicated in colorectal tumor progression. As model systems we used the SW48 and HCT116 cell lines, which harbor wild type and mutant KRAS respectively. Parental and derivative cells, in which MLK4 expression was reduced or abrogated, were compared side by side. Cells were treated with EGF and activation of the ensuing signaling pathways was analyzed. Ligand-mediated receptor tyrosine phosphorylation was unaffected by abrogation of MLK4 expression indicating that MLK4 does not directly modulate activation of RTKs (Supplementary Fig. 3A-B).

Further investigation of the MAPK signaling cascade revealed that lack of MLK4 slightly reduced ligand dependent phosphorylation of MEK and ERK kinases only in the KRAS mutated cells (Supplementary Fig. 3B). Considering the striking phenotype we had previously observed when cells lacking MLK4 were grown in the absence of anchorage (Figure 4A), we assessed whether MLK4 affected MAPK signaling under this experimental condition. MLK4 knock out cells were seeded and allowed to grow for various period of time in the absence of anchorage using ultra-low attachment surface flasks. As previously reported (16), when the parental cells were grown in the absence of anchorage the expression of E-cadherin, an epithelial surface marker, was increased. At the same time MAPK activation, as measured by MEK and ERK phosphorylation, was observed (Figure 6). Under these conditions activation of MEK1 was evidently lower in the absence of MLK4. Levels of active ERK, the most common MEK1 substrate, were also decreased in

MLK4 <sup>-/-</sup> cells. The correlation between MLK4 down-regulation and MEK-ERK phosphorylation was also assessed in one additional CRC cellular model (DLD1) in which MLK4 expression was down-regulated by ShRNAs as described above. As shown in Supplementary Fig. 4, the reduction of MEK-ERK phosphorylation was consistently observed also in DLD1 knock down cells.

## DISCUSSION

In the past five years the mutational profile of multiple tumor types including colon, lung, breast, GBMs, pancreas and prostate have been completed. With few exceptions these studies revealed that there are very few genes mutated at high frequency. Among those, the ones that are constitutively activated (oncogenic) and considered pharmacologically “druggable” are just a handful. *Mixed Lineage Kinase 4* (MLK4) is the most frequently mutated protein kinase in microsatellite stable CRC (2). The role of MLK4 and its somatic variants in CRC is presently unknown. In light of its potential as a novel therapeutic target we have assessed the biochemical and functional properties of mutant MLK4 and the role of the MLK4 gene in sustaining the transformed phenotype in colorectal cancer cells.

We report that MLK4 mutant alleles display increased kinase activity as compared to wt indicating that MLK4 mutations are activating like those affecting other kinases such as BRAF, MEK, ALK, EGFR and MET.

MLK4 mutations can be found independently or can co-occur with mutated KRAS in CRCs. The co-occurrence of KRAS and MLK4 mutations in some tumors is evocative of the pattern of mutations in the lipid kinase PI3K $\alpha$  which is also mutated either alone or in concomitance with *KRAS*. Notably, we report that mutant MLK4 enhances RAS-promoting cell transformation. This behavior is reminiscent of other cancer genes (such as Pokemon) whose transforming potential becomes

detectable only when assessed in cooperation with the RAS oncogenes (18). Our results are therefore consistent with a role for MLK4 in the RAS pathway just like that of the PI3K $\alpha$  (17). In fact, the genetic removal of either wild type PIK3CA (17) or MLK4 (this study) affects the oncogenic potential of RAS resulting in an impaired tumor growth and metastasis formation. ~~Furthermore, mutant MLK4 enhances RAS-promoting cell transformation. This behavior is reminiscent of other cancer genes (such as Pokemon) whose transforming potential becomes detectable only when assessed in cooperation with the RAS oncogenes (18).~~

Our biochemical analysis suggest that the MLK4 kinase may act within the RAS-MAPK signaling pathway: indeed MLK4 can phosphorylate MEK1 on serine 217 and 221 which are located in the activation loop and are known to induce MEK activation. MLK4 may therefore trigger MAPK signaling, just like the RAF kinases, acting as a MAP3K. Notably- unlike RAFs proteins- MLK4 does not contain a Ras Binding Domain (RBD), making it unlikely that MLK4 could be directly activated by binding to active RAS.

While in this work we have established at least one of the downstream pathways in which MLK4 is involved, the upstream activators of MLK4 are presently speculative. In this respect we find that MLK4 modulates the activation of the MEK-ERK cascade when tumor cells are under stressful circumstances, such as in non-adherent conditions. We speculate that in the absence of anchorage MLK4 could



be activated by a RAS effector, such as Cdc42. Intriguingly, it has been shown that both Cdc42 and Rac play a role in preventing detachment-induced apoptosis (anoikis) in transformed epithelial cells (19, 20). Furthermore, previous work indicates that Cdc42 is a physiological activator of the closely related kinase MLK3 (7). Cdc42 induces membrane targeting and activation by autophosphorylation of MLK3, which is dependent upon an intact Cdc42/Rac-interactive (CRIB) binding motif (7). Importantly, MLK4 also carries a CRIB domain, and it is possible that Cdc42 or other small GTP binding proteins (like Rac) could act as upstream activators of MLK4 through a similar mechanism.

The finding that the transcriptional silencing or genetic inactivation of the MLK4 gene severely reduces or abrogates the tumorigenicity of cancer cells carrying KRAS or BRAF mutations is noteworthy. We and others have previously inactivated multiple oncogenes including *MET* (21), *KRAS* (15) and *PIK3CA* (22) in colorectal cancer cells. While targeting of these oncogenes drives distinct biological phenotypes, only the deletion of mutated *KRAS* or MLK4 results in abrogation of tumorigenesis.

Activating KRAS mutations are present at high frequency in multiple tumor types such as CRC, lung, pancreas cancer. KRAS mutated tumors are characterized by poor prognosis and lack of response to therapies. As the Ras protein has proven hard, if not impossible, for direct pharmacological inhibition, recent efforts have been directed at identifying “druggable” targets that could be synthetically lethal

with oncogenic Ras (23-26). MLK4 has never been reported as "hit" in mutant KRAS synthetic lethality screenings using genome-wide ShRNA suppression libraries. These screens have mainly relied, as biological read-outs, on proliferation assays in a two dimensional format. We found that in these conditions the effect of MLK4 is not apparent. We therefore suggest that similar approaches should be performed using anchorage-independent conditions, as this may be critical to identify additional mediators of oncogenic RAS.

In conclusion this work provides genetic and functional evidences that MLK4 mutants are constitutively active and that genetic inactivation of MLK4 suppresses the growth of KRAS mutant CRCs. As the MLK4 kinase activity is amenable for direct pharmacological inhibition, the development of MLK4 inhibitors is warranted and may prove relevant for the treatment of KRAS- driven tumors.

## **ACKNOWLEDGMENTS**

We are grateful to Emily Crowley, Chris Torrance, Sabrina Arena, Federica Di Nicolantonio, Steina Thorlacious and Davide Zecchin for suggestions and for critically reading the manuscript. We thank Asha Balakrishnan and Silvia Benvenuti for help with the initial mutational analysis. We thank Margaret Knowles, Carmine Pinto, Monica Rodolfo and Fonet Bleeker for supplying tumor samples. MM wish to give thanks to her family for their encouragement and to Fabio Cantore for his extemporaneous support.

## **GRANT SUPPORT**

Work in the laboratories of the authors is supported by the Italian Association for Cancer Research (AIRC), Italian Ministry of Health, Regione Piemonte, Italian Ministry of University and Research, CRT Progetto Alfieri, FP-7 EU Marie Curie Programme, Association for International Cancer Research UK, European Union FP6, MCSCs contract 037297, AIRC 2010 Special Program Molecular Clinical Oncology 5xMille, Project n° 9970.

## **Authors contribution**

**Concept and design:** M.Martini and A.Bardelli

**Development of methodology:** M.Martini, M.Russo and A.Bardelli

**Acquisition of data:** M.Martini, M.Russo, S.Lamba, E.Vitiello, F.Sassi,  
D.Romanelli

**Analysis and interpretation of data:** M.Martini, M.Russo, S.Lamba, M.Frattini,  
A.Marchetti and A.Bardelli

**Writing, review and/or revision of the manuscript:** M.Martini, M.Russo and  
A.Bardelli

**Administrative, technical, or material support:** F.Sassi, D.Romanelli and  
M.Frattini

**Study supervision:** A.Bardelli

## REFERENCES

1. Pao W, Girard N. New driver mutations in non-small-cell lung cancer. *The lancet oncology*. 2011;12:175-80.
2. Network TCGA. Comprehensive molecular characterization of human colon and rectal cancer. *Nature*. 2012;487:330-7.
3. Bardelli A, Parsons DW, Silliman N, Ptak J, Szabo S, Saha S, et al. Mutational analysis of the tyrosine kinome in colorectal cancers. *Science (New York, NY)*. 2003;300:949.
4. Popat S, Hubner R, Houlston RS. Systematic review of microsatellite instability and colorectal cancer prognosis. *J Clin Oncol*. 2005;23:609-18.
5. Chadee DN, Kyriakis JM. MLK3 is required for mitogen activation of B-Raf, ERK and cell proliferation. *Nature cell biology*. 2004;6:770-6.
6. Chadee DN, Xu D, Hung G, Andalibi A, Lim DJ, Luo Z, et al. Mixed-lineage kinase 3 regulates B-Raf through maintenance of the B-Raf/Raf-1 complex and inhibition by the NF2 tumor suppressor protein. *Proceedings of the National Academy of Sciences of the United States of America*. 2006;103:4463-8.
7. Du Y, Bock BC, Schachter KA, Chao M, Gallo KA. Cdc42 induces activation loop phosphorylation and membrane targeting of mixed lineage kinase 3. *The Journal of biological chemistry*. 2005;280:42984-93.
8. Zhang H, Gallo KA. Autoinhibition of mixed lineage kinase 3 through its Src homology 3 domain. *The Journal of biological chemistry*. 2001;276:45598-603.
9. Gallo KA, Johnson GL. Mixed-lineage kinase control of JNK and p38 MAPK pathways. *Nature reviews*. 2002;3:663-72.
10. Chadee DN, Kyriakis JM. A novel role for mixed lineage kinase 3 (MLK3) in B-Raf activation and cell proliferation. *Cell cycle (Georgetown, Tex)*. 2004;3:1227-9.
11. Michieli P, Li W, Lorenzi MV, Miki T, Zakut R, Givol D, et al. Inhibition of oncogene-mediated transformation by ectopic expression of p21Waf1 in NIH3T3 cells. *Oncogene*. 1996;12:775-84.
12. Follenzi A, Ailles LE, Bakovic S, Geuna M, Naldini L. Gene transfer by lentiviral vectors is limited by nuclear translocation and rescued by HIV-1 pol sequences. *Nature genetics*. 2000;25:217-22.
13. Kohli M, Rago C, Lengauer C, Kinzler KW, Vogelstein B. Facile methods for generating human somatic cell gene knockouts using recombinant adeno-associated viruses. *Nucleic acids research*. 2004;32:e3.
14. Davies H, Bignell GR, Cox C, Stephens P, Edkins S, Clegg S, et al. Mutations of the BRAF gene in human cancer. *Nature*. 2002;417:949-54.
15. Shirasawa S, Furuse M, Yokoyama N, Sasazuki T. Altered growth of human colon cancer cell lines disrupted at activated Ki-ras. *Science (New York, NY)*. 1993;260:85-8.
16. Mueller S, Cadenas E, Schonthal AH. p21WAF1 regulates anchorage-independent growth of HCT116 colon carcinoma cells via E-cadherin expression. *Cancer research*. 2000;60:156-63.
17. Gupta S, Ramjaun AR, Haiko P, Wang Y, Warne PH, Nicke B, et al. Binding of ras to phosphoinositide 3-kinase p110alpha is required for ras-driven tumorigenesis in mice. *Cell*. 2007;129:957-68.

18. Maeda T, Hobbs RM, Merghoub T, Guernah I, Zelent A, Cordon-Cardo C, et al. Role of the proto-oncogene *Pokemon* in cellular transformation and ARF repression. *Nature*. 2005;433:278-85.
19. Zugasti O, Rul W, Roux P, Peyssonnaud C, Eychene A, Franke TF, et al. Raf-MEK-Erk cascade in anoikis is controlled by Rac1 and Cdc42 via Akt. *Molecular and cellular biology*. 2001;21:6706-17.
20. Cheng TL, Symons M, Jou TS. Regulation of anoikis by Cdc42 and Rac1. *Experimental cell research*. 2004;295:497-511.
21. Arena S, Pisacane A, Mazzone M, Comoglio PM, Bardelli A. Genetic targeting of the kinase activity of the Met receptor in cancer cells. *Proceedings of the National Academy of Sciences of the United States of America*. 2007;104:11412-7.
22. Samuels Y, Diaz LA, Jr., Schmidt-Kittler O, Cummins JM, DeLong L, Cheong I, et al. Mutant PIK3CA promotes cell growth and invasion of human cancer cells. *Cancer cell*. 2005;7:561-73.
23. Barbie DA, Tamayo P, Boehm JS, Kim SY, Moody SE, Dunn IF, et al. Systematic RNA interference reveals that oncogenic KRAS-driven cancers require TBK1. *Nature*. 2009;462:108-12.
24. Luo J, Emanuele MJ, Li D, Creighton CJ, Schlabach MR, Westbrook TF, et al. A genome-wide RNAi screen identifies multiple synthetic lethal interactions with the Ras oncogene. *Cell*. 2009;137:835-48.
25. Scholl C, Frohling S, Dunn IF, Schinzel AC, Barbie DA, Kim SY, et al. Synthetic lethal interaction between oncogenic KRAS dependency and STK33 suppression in human cancer cells. *Cell*. 2009;137:821-34.
26. Puyol M, Martin A, Dubus P, Mulero F, Pizcueta P, Khan G, et al. A synthetic lethal interaction between K-Ras oncogenes and Cdk4 unveils a therapeutic strategy for non-small cell lung carcinoma. *Cancer cell*. 2010;18:63-73.

## FIGURE AND TABLE LEGENDS

### Table 1. Somatic mutations in the MLK4 gene in CRCs and glioblastomas

The table lists the mutations in the MLK4 gene that were confirmed to be somatic, the tumor type where they have been identified and the KRAS/BRAF status of the corresponding sample. C, residue is evolutionarily conserved; K, residue is within kinase domain; STY, serine threonine tyrosine kinase domain; CC, coiled coil; indel, insertion/deletion. Domains were defined according to the HPRD database (<http://www.hprd.org>).

### Figure 1. Genetic and functional analysis of MLK4 mutations

A) Schematic representation of MLK4 structure and its functional domains. The position of the somatic mutations is reported. Previously found mutations are reported in black, newly found mutations are reported in red, new mutations identical to those previously found are framed.

B) Focus forming assay in NIH3T3 cells transfected with wt and mutant MLK4 alleles. Ras (V12) is used as a positive control. \*\*p value  $\leq 0.01$ ; error bars represent s.d.

C) Focus forming assay in NIH3T3 cells co-transfected with mutant Ras (V12) and wt/mutant MLK4 alleles. \*\*p value  $\leq 0.01$ ; \*\*\*p value  $\leq 0.001$ ; error bars represent s.d.

**Figure 2. MLK4 mutants cooperate with oncogenic RAS in transformation and tumor formation**

A) Western-blot analyses of MLK4 proteins, wt and different mutants. HCT116 cells lacking endogenous MLK4 were transduced with indicated vectors and MLK4 expression levels were assessed by immunoprecipitation (Ab anti-N MLK4). The wt or mutant MLK4 proteins (K151A, H261Y, G291E, R470C and R555Stp) are indicated.

B) Relative kinase activity of MLK4 wt and mutant alleles in cells lacking endogenous MLK4. Detailed description of the MLK4 knock-out cells is reported in Figure 3. Kinase activity was calculated as the ratio between total MLK4 protein and the amount of ATP consumption. Results were normalized using the activity of wild type MLK4 as a reference. \*\*p value  $\leq 0.01$ ; error bars represent s.d.

C) Tumor formation by DLD1 cancer cells expressing wild type or two MLK4 mutants in xenograft mouse models. Cells were injected in the side of nude mice and tumor growth was measured at the indicated time points. Error bars represent s.e.m.

D) DLD-1 colorectal cancer cells expressing wild type or mutant MLK4 were injected in nude mice. At the end of the experiment the animals were sacrificed and the lungs were labeled by airway perfusion with the India ink. Metastases (colonies of cells growing on the surface of the lungs) were counted under a stereoscopic microscope. \*p value  $\leq 0.05$ ; \*\*p value  $\leq 0.01$ ; error bars represent s.e.m.



**Figure 3. Generation of knock down and knock out cellular models of MLK4**

A) Two independent ShRNAs targeting the MLK4 gene were used to down-regulate MLK4 expression in cell lines derived from colorectal and lung tumors.

Expression levels of the MLK4 protein were assessed by western blotting.

B) Schematic representation of the vector used to Knock Out the MLK4 genes from the genome of HCT116 colorectal cancer cells. A sequential targeting strategy was used to knock out both MLK4 alleles. L-ITR: Left-Inverted Terminal Repeats, P: neomycin promoter, Neo: neomycin resistance cassette, pA: polyadenylation sequence, R-ITR: Right-Inverted Terminal Repeats.

C) Expression of the MLK4 protein assessed by western blotting in parental and two independent clones of HCT116 cells MLK4 knock-out.

**Figure 4. Genetic deletion or downregulation of MLK4 impairs transforming potential of human cancer cells carrying mutated KRAS.**

A) Anchorage-independent growth (soft agar) assay performed on parental and MLK4 knock down/knock out cells. \*p value  $\leq 0.05$ ; \*\*p value  $\leq 0.01$ ; \*\*\*p value  $\leq 0.001$ ; error bars represent s.d.

B) Control and MLK4 knock-down DLD1 cancer cells were injected in the side of nude mice and tumor growth was measured at the indicated time points. Error bars represent s.e.m.

C) Control and MLK4 knock-out HCT116 cancer cells were injected in nude mice and tumor growth was measured at the indicated time points. Error bars represent s.e.m.

**Figure 5. MLK4 phosphorylates MEK1**

A) MLK4-mediated phosphorylation of kinase inactive ERK2 (K45R) and MEK1 (K97M) at different ATP concentrations. KD, Kinase Dead.

B) Residue-specific phosphorylation of ERK2 and MEK1 by purified MLK4 was assessed by western blotting with the indicated phospho-specific antibodies.

**Figure 6. Inactivation of MLK4 impairs MAPK-signaling initiated by loss of anchorage**

Parental and MLK4 knock out HCT116 cells were seeded and allowed to grow for the indicated times in flasks with ultra-low attachment surface to prevent cell adhesion. Cells were harvested and protein lysates were subjected to western blotting with the indicated antibodies.

## **SUPPLEMENTARY FIGURE AND TABLE LEGENDS**

### **Supplementary Table 1**

List of tumors and number of samples for each histological type used for the mutational profile of MLK4 (GIST: Gastrointestinal Stromal tumors)

### **Supplementary Table 2**

Primers used for PCR amplification and sequencing of the MLK4 exons in tumor samples.

### **Supplementary Figure 1**

A) Tumors formed by A549 cancer cells expressing wild type or two MLK4 mutants in xenograft mouse models. Cells were injected in the side of nude mice and tumor growth was measured at the indicated time points. Error bars represent s.e.m.

B) Upon sacrifice the lungs were labeled by airway perfusion with the India ink, and superficial metastases were counted as described in panel C. \*p value  $\leq 0.05$ ; \*\*p value  $\leq 0.01$ ; error bars represent s.e.m.

### **Supplementary Figure 2**

A) Proliferation rates of HCT116 parental and MLK4  $-/-$  cancer cells (two independent clones). \*p value  $\leq 0.05$ ; \*\*p value  $\leq 0.01$ ; error bars represent s.d; FC, fold change.

B) Expression levels of the MLK4 protein were assessed by western blotting in control (ctrl) and MLK4 knock down LoVo cells.

C) Proliferation rates of ctrl and MLK4 knock down LoVo cells grown in plastic . \*p value  $\leq 0.05$ ; \*\*p value  $\leq 0.01$ ; error bars represent s.d; FC, fold change.

D) Proliferation rates of Ctrl and MLK4 knock down LoVo cells grown in low adherence conditions. \*p value  $\leq 0.05$ ; \*\*p value  $\leq 0.01$ ; error bars represent s.d; FC, fold change.

E) Anchorage-independent growth (soft agar) assay performed on control and MLK4 knock down LoVo cells. \*\*\*p value  $\leq 0.001$ ; error bars represent s.d.

### **Supplementary Figure 3**

A) Ctrl and MLK4 knock down (Sh1 and Sh2) Sw48 cells were stimulated with EGF (2nM-20 nM) at 37 °C for 10 minutes. Cell lysates were subjected to western blotting with the indicated antibodies.

B) Parental and MLK4  $-/-$  HCT116 cells were stimulated with EGF (2nM-20 nM) at 37 °C for 10 minutes. Cell lysates were subjected to western blotting with the indicated antibodies.

### **Supplementary Figure 4**

Ctrl and MLK4 knock down DLD (A) were seeded and allowed to grow for the indicated times in flasks with ultra-low attachment surface to prevent cell adhesion. Cells were harvested and protein lysates were subjected to western blotting with the indicated antibodies.

**Table 1**

Tumor type	Nucleotide (cDNA)	Amino Acid (Protein)	Residue Properties	Exon	Functional Domain	Mutation type	KRAS	BRAF	MSI/MSS
CRC	T964C	S322P	C, K	2	STY kinase	Missense	NRAS Q61L	WT	MSS
CRC	G1326A	R442Q	C	5	CC	Missense	WT	V600E	MSI
CRC	G1409A	R470H	C	5	CC	Missense	WT	WT	MSI
CRC	C1408T	R470C	C	5	CC	Missense	G13D	WT	MSS
CRC	A1480C	K494Q	-	5	None	Missense	WT	WT	MSS
CRC	C1657T	R553Stp	C	6	None	Nonsense	WT	V600E	MSI
GBM	C1663T	R555Stp	C	6	None	Nonsense	WT	NA	NA
CRC	1700delA	FS	-	7	None	Indel	WT	WT	MSI
CRC	1702insT	FS	-	7	None	Indel	WT	WT	MSI
CRC	C2788T	P843S	-	9	None	Missense	G12D	WT	MSS
GBM	C2788T	P843S	-	9	None	Missense	WT	NA	NA

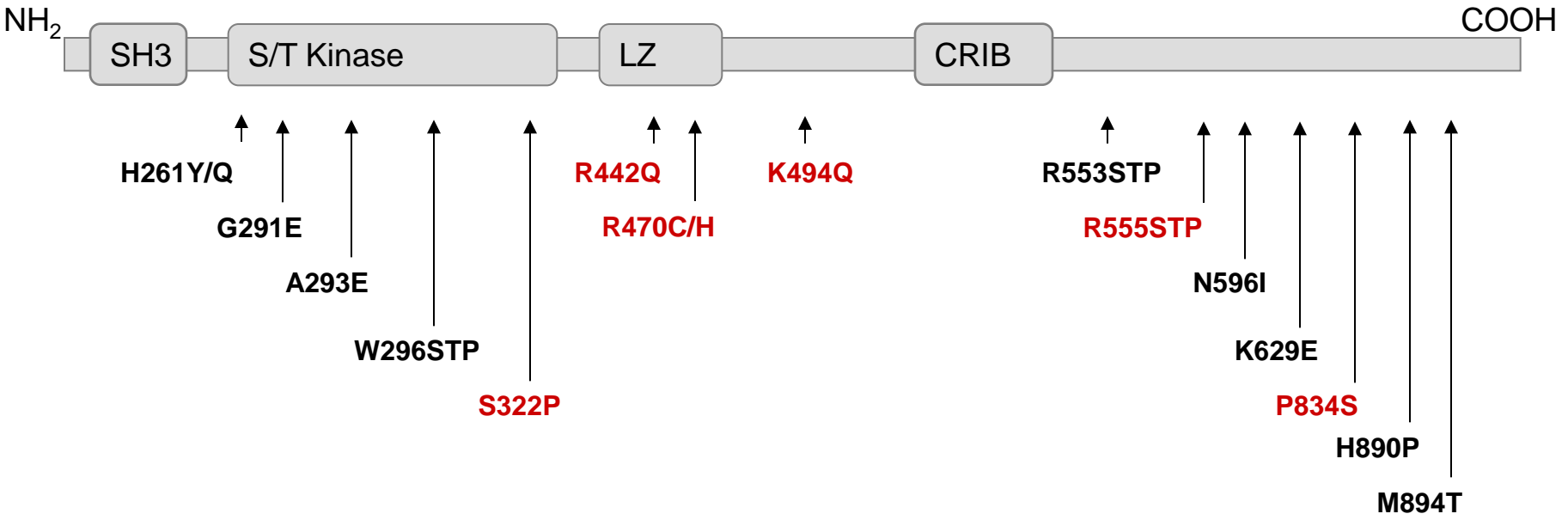
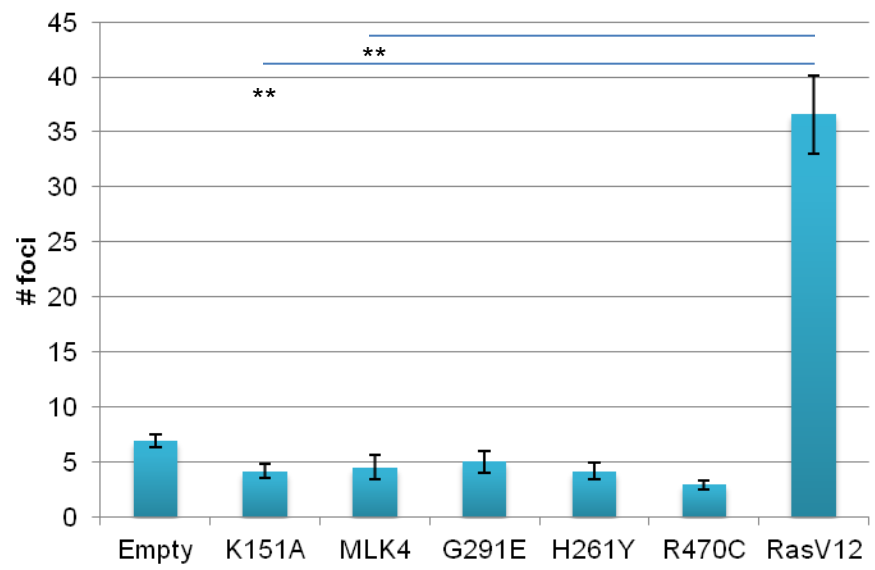
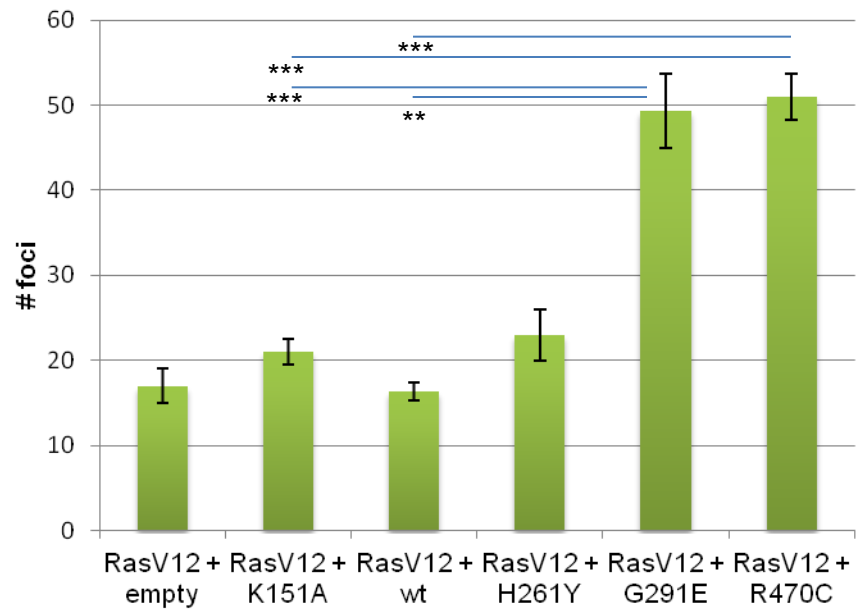
**A****B****C**

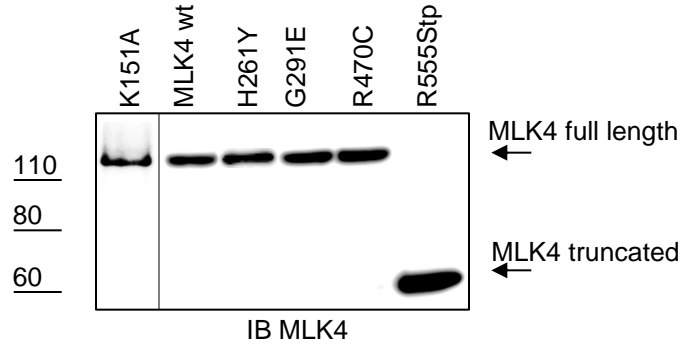
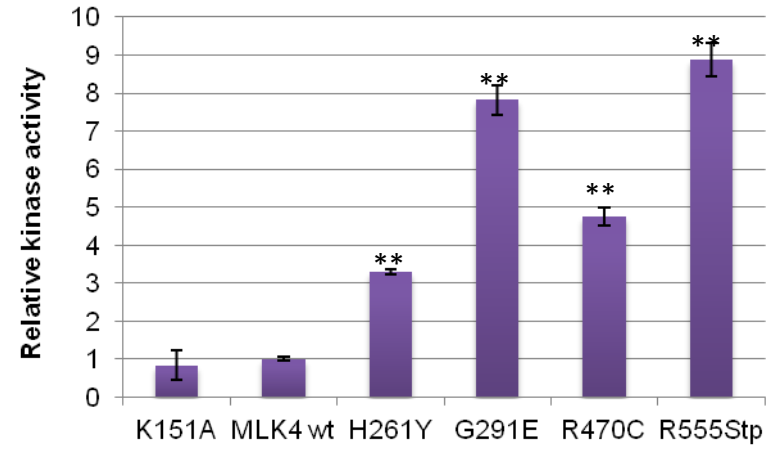
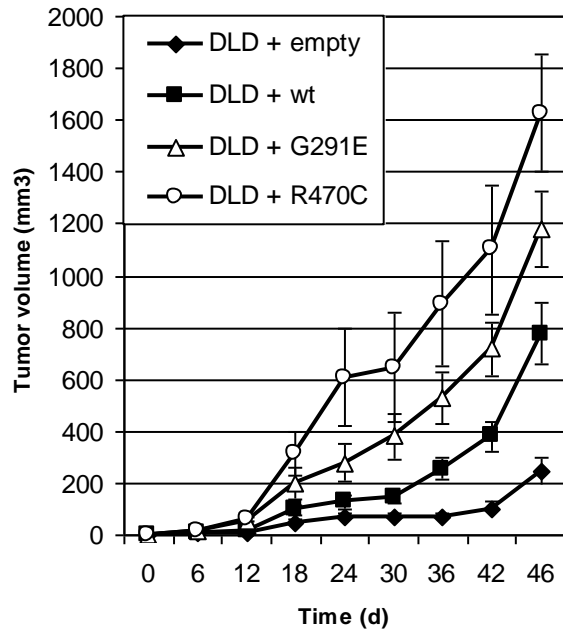
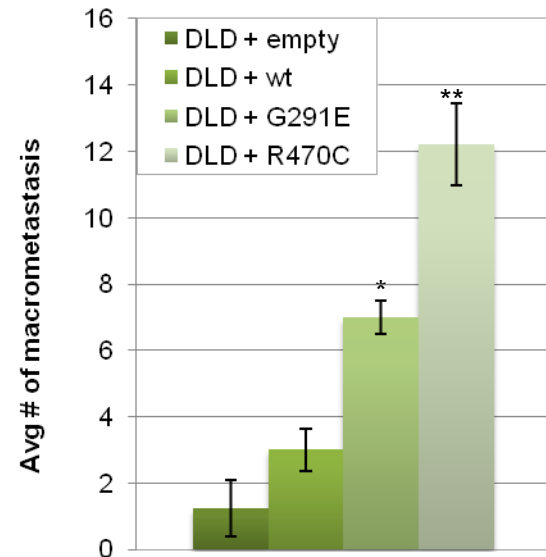
**A****B****C****D**

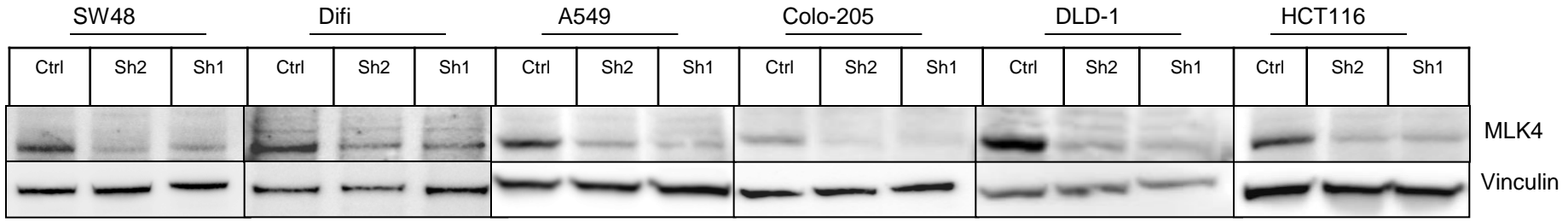
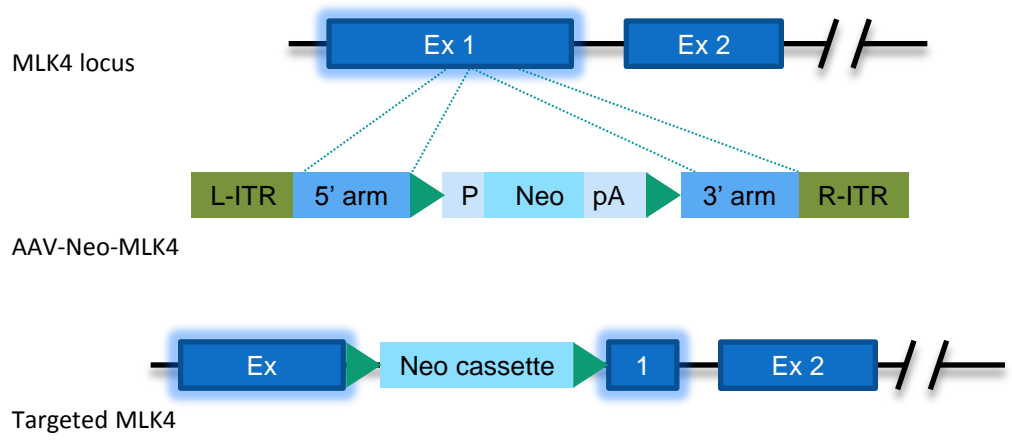
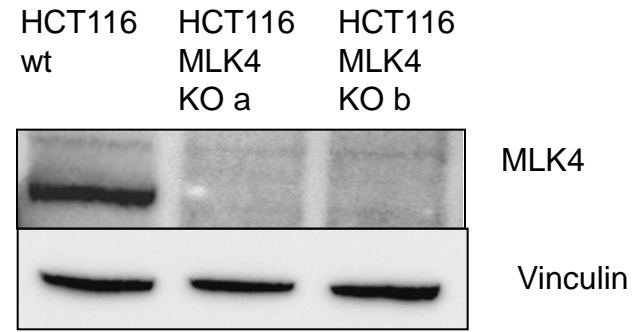
**A****B****c**



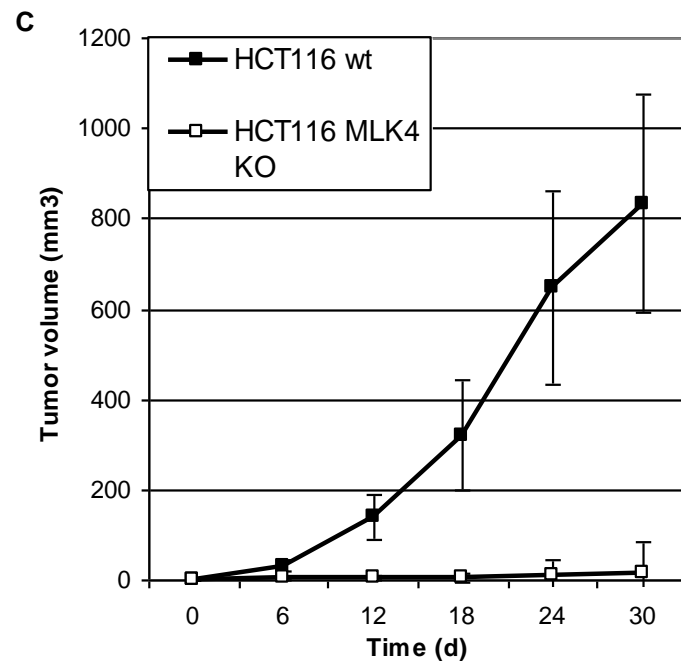
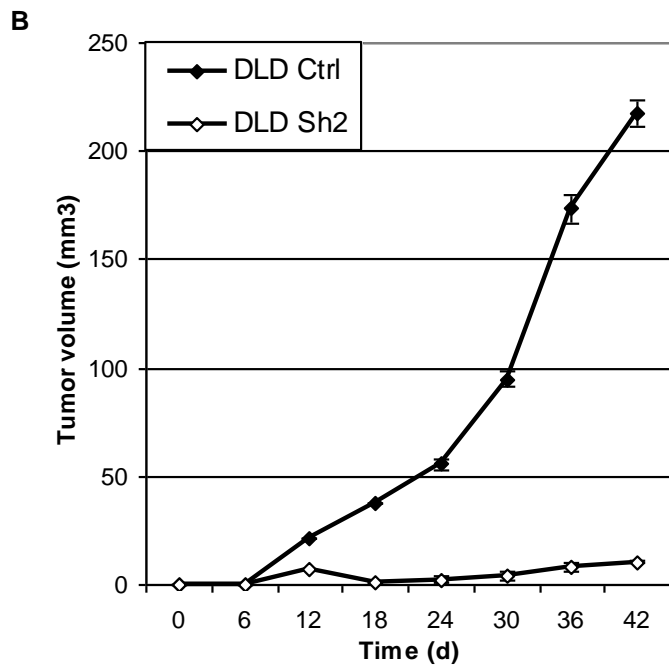
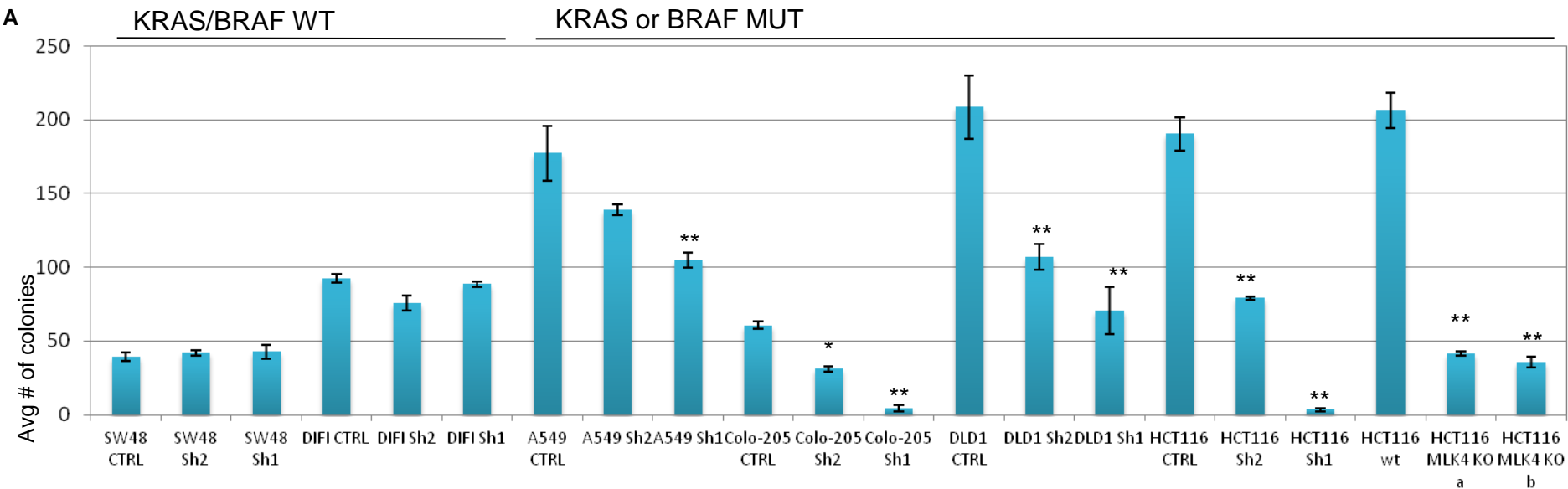

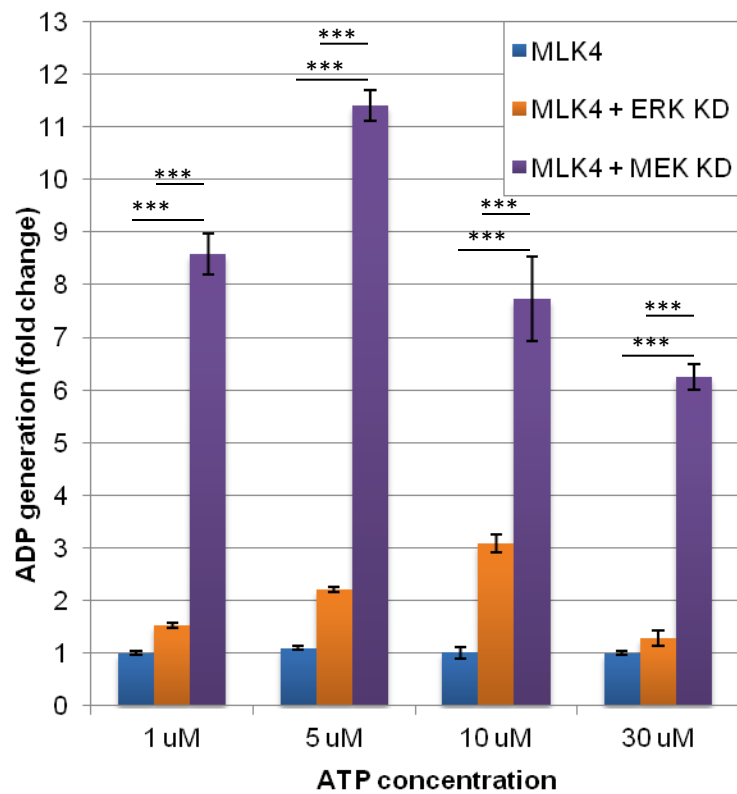
**A****B**