

AperTO - Archivio Istituzionale Open Access dell'Università di Torino

1,3- and 1,2-Unsaturated Derivatives as Valuable Synthetic Tools in Organometallic Syntheses

This is the author's manuscript

Original Citation:

Availability:

This version is available <http://hdl.handle.net/2318/71921> since 2016-10-27T11:44:52Z

Terms of use:

Open Access

Anyone can freely access the full text of works made available as "Open Access". Works made available under a Creative Commons license can be used according to the terms and conditions of said license. Use of all other works requires consent of the right holder (author or publisher) if not exempted from copyright protection by the applicable law.

(Article begins on next page)

1,3- and 1,2-Unsaturated Derivatives as Valuable Synthetic Tools in Organometallic Syntheses

Annamaria Deagostino, Cristina Prandi, Silvia Tabasso, and Paolo Venturello

Dipartimento di Chimica Generale e Chimica Organica dell'Università di Torino

Via Pietro Giuria, 7 - 10125 Torino (Italy)

ABSTRACT

This review gives an overview of our recent developments in the chemistry of 1,3- and 1,2-butadiene derivatives, with a special attention to their use in palladium catalyzed reactions. The reactions of α,β -unsaturated and propargylic acetals with various lithium and mixed lithium-potassium Schlosser reagents will be firstly reviewed. These processes have afforded (*E*)-1-alkoxy-1,3-dienes, and (*E*)-1,3-enynes, 1,3-diynes or allenes, respectively. When the reactions have been carried out in the presence of suitable electrophiles a linear route to functionalized derivatives has been set up. The above-mentioned compounds can be thus considered valuable synthetic tools for the construction of various and more complex structures and, in particular, they have been established to be useful reagents for the Suzuki-Miyaura cross-coupling reaction. As a matter of fact, alkoxy-functionalized butadienylboronic esters have been synthesized, cross-coupled with both *N*-protected and *N*-unprotected haloanilines (or halophenols), and finally transformed under mild conditions into quinolines and quinolinones (or chromenes and chromenones). The second part of the paper will deal with our recent interest in the Heck coupling of conjugate systems. In particular, the synthesis of γ -arylated α,β -unsaturated carbonyl compounds, by regioselective Heck process on 1-alkoxy-1,3-dienes in ionic liquids will be reviewed, in conjunction with the Heck coupling of 1,2-dien-1-ols to α -arylated α,β -unsaturated aldehydes. A survey of the recent literature on closely related topics will complete the contribution.

Keywords: 1,3-dienes, 1,3-enynes, 1,3-diynes, allenes, organometallic reagents, cross-coupling reactions, Pd-catalysts.

- 1 1,3-Butadienes
 - 1.1 Lithium 1,3-Butadienes
 - 1.2 1-Metalated-1-Alkoxy-1,3-Butadienes
- 2 1,3-Enynes: Syntheses and Applications
 - 2.1 Synthesis
 - 2.2 Applications
3. Syntheses of Quinoline and Chromenone Framework
 - 3.1 Quinoline and Chromenones from Alkoxy-1,3-Dienes
4. Pd Catalyzed Reactions of 1,3- and 1,2-Dienes.
 - 4.1. Heck Reaction
 - 4.2 Sonogashira Reaction
 - 4.3 Suzuki Coupling
 - 4.4 Stille Coupling
 - 4.5 Miscellaneous

INTRODUCTION

Great advancement has been achieved in recent years in broadening the scope of palladium-catalyzed synthetic organic cross-couplings. The variety of these reactions is exemplified by the huge number of named reactions in this field (Heck-Mizoroki, Suzuki-Miyaura, Sonogashira, Stille, Kumada, Negishi, Buchwald-Hartwig, and others). The regio- and stereoselective synthesis of unsaturated derivatives is of great value in organic chemistry by itself, as well as its utilization in other reactions. Various new methods for the preparation of conjugated dienes have been so far developed, it is in fact known that substituted alkenes, dienes, and other unsaturated systems, are useful intermediates for the preparation of dyes, UV screens, and drugs. In connection with this increasing attention for unsaturated conjugated systems, all methods that allow straightforward modification of these derivatives deserve to be quoted. This review describes the most recent developments in the palladium-mediated coupling reactions of 1,3- and 1,2-unsaturated systems as well as their metalation and functionalization with suitable electrophiles including our own results in this field.

1. 1,3-Butadienes

1.1. Lithium 1,3-Butadienes

Development of organometallic reagents is a challenging area in modern synthetic chemistry, since it can afford new synthetic tools that may remarkably accelerate the advances in synthesis and related subjects. In particular, metalated 1,3-dienes proved to be versatile building blocks for the preparation of a wide variety of linear and cyclic compounds. The Xi's group gave a significant contribution to the development of this kind of chemistry.¹

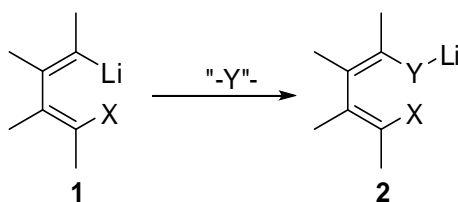
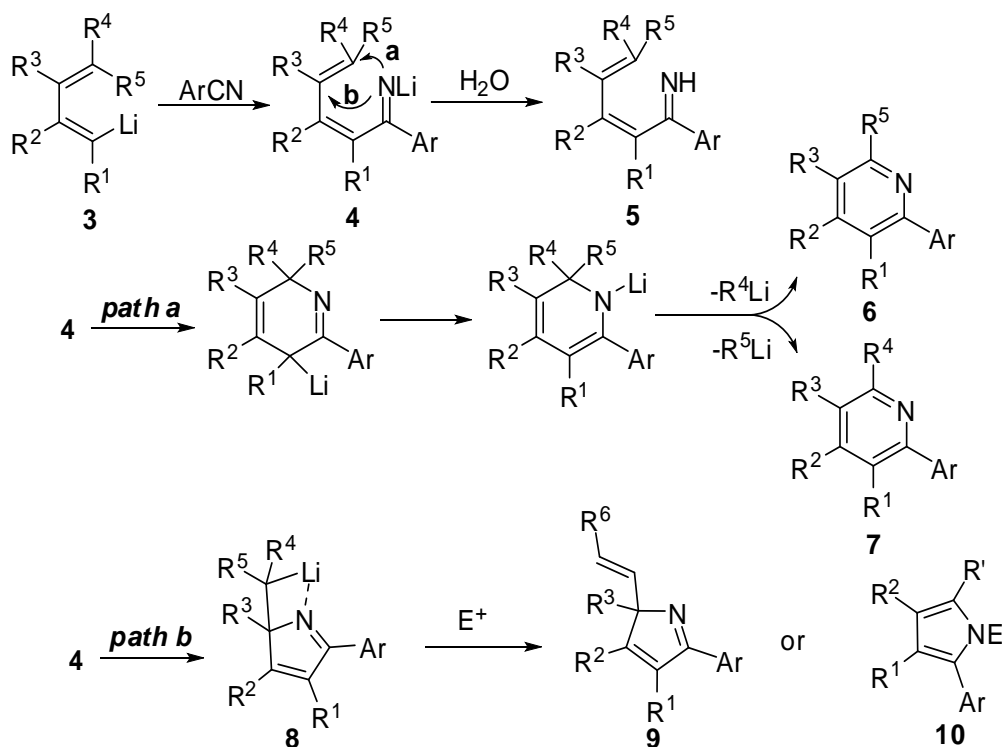

Figure 1. Reaction pattern of 1-lithio-1,3-dienes with unsaturated electrophiles

1-Lithio-1,3-butadienes are prepared generally *in situ* by lithium-halogen exchange of the corresponding 1-halo-1,3-butadienes, or mixed 1,4-halo-1,3-butadienes, with BuLi, or *t*-BuLi. The alkenyllithium moiety **1** reacts with a variety of unsaturated organic substrates "-Y-" to yield a first intermediate **2** as shown in Figure 1. When the substituent X is a functional group as Cl, Br, vinyl, naphthyl, Ph, SiMe₃, Me the alkenyllithium moiety in **1** and the Y-Li moiety in **2** can react intramolecularly with X to afford cyclic compounds.

Reactions with organonitriles. Among the various electrophiles that have been used in addition reactions with 1-lithium-1,3-butadienes,² organonitriles provides an useful synthetic tool for the synthesis of N-containing heterocycles. Depending on the substitution patterns of the butadienyl skeletons, substituted pyridines, pyrroles and/or linear butadienyl imines were formed.



Scheme 1. Reaction and paths of lithium butadienes with organonitriles

At $-78\text{ }^{\circ}\text{C}$ linear ketimines **5** form by addition of the butadienyl lithium nucleophile **3** to the organonitrile, whilst at higher reaction temperatures an intramolecular lithiation-cyclization occurs to form cyclic intermediates which affords pyridine and/or pyrroles derivatives as the final products. As depicted in Scheme 1, a competition between path a and path b is operating in this reaction. Competition between **5-*exo*** and **6-*endo*** cyclization was found to be responsible for the formation of either pyrroles and pyridines. The substitution patterns on the butadienyl skeleton strongly affects the reaction paths. For instance, 1,2-disubstituted 1-lithio-1,3-dienes afford exclusively pyrroles derivatives upon heating at reflux. Interestingly, when the substitution pattern on the butadienyl skeleton of monolithium reagents was changed to 2,3-disubstituted patterns the reaction with organonitriles afforded pyridine derivatives as the only product.

Reactions with isocyanates. Functionalized dienamides **12** (Scheme 2) are easily obtained by reaction of 1-lithio-1,3-butadienes with *N*-aryl or *N*-alkyl isocyanates. The acidic promoted electrophilic cyclization of **12** gave exclusively *exo* cyclic imino ethers through the *O*-attack pathway. No products coming from the *N*-attack or *endo* heterocycles were observed. Substitution

at the γ -position of the dienamides and the relatively stability of the allylic carbocation might be essential for the *exo* products from *O*-attack.

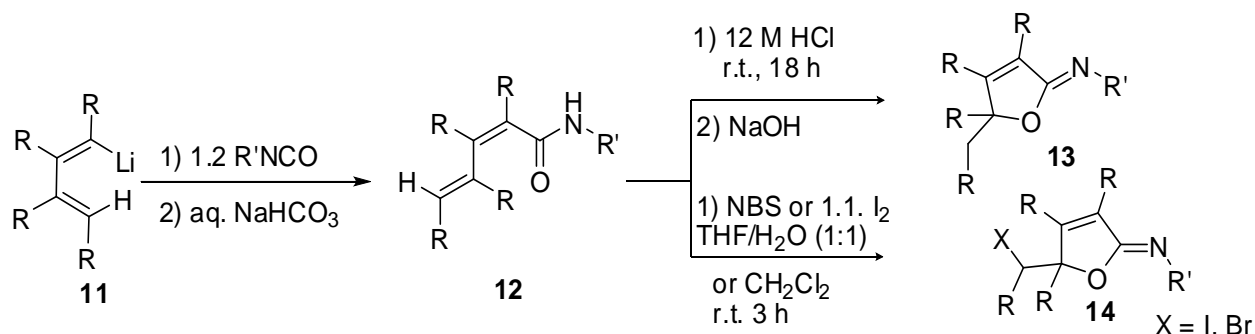

Scheme 2. Formation, NBS or I_2 promoted cyclization of dienamides **12**

Reactions with CO. Cyclopentenone derivatives **15** have been readily obtained by reacting 1-lithium-1,3-butadiens³ **11**, these ones generated in situ by lithiation with *t*-BuLi of the corresponding 1-iodo-1,3-dienes, with CO (g) and then quenching with water or other electrophiles (Scheme 3). Conceptually, the process corresponds to an acyl-lithiation reaction of C–C double bonds in which a tandem carbonylation/cyclo-acylation takes place.

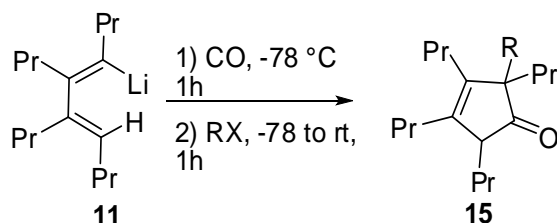

Scheme 3. Reaction of 1-lithio-1,3-dienes with CO and electrophiles

1.2 1-Metalated-1-Alkoxy-1,3-Butadienes

Since 1992 we found that α,β -unsaturated acetals **16**, treated with 2 equivalents of superbase LIC–KOR,⁴ stereoselectively afford 1-metalated-1-alkoxy-1,3-dienes **17**.⁵ These derivatives can react with various electrophiles, among them alkyl halides, carbonyl compounds, and epoxides to give 1-alkoxyfunctionalized dienes **18** that, upon hydrolysis under mild conditions, furnish α,β -unsaturated ketones **19**. The whole process may be accounted for an *umpolung* sequence in which a carbonyl function has been reacted with an electrophile (Scheme 4). Description of this chemistry has been reported elsewhere.^{6,7}

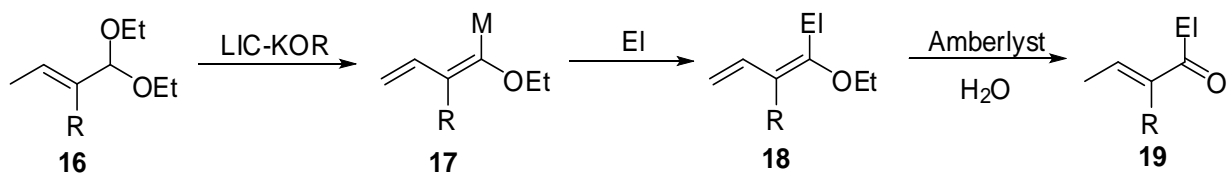

Scheme 4. Formation of functionalized ethoxydienes and ketones from α,β -unsaturated acetals

Reactions with Organonitriles. The development of new synthetic methodologies for the preparation of *N*-containing heterocycles is a continuously expanding field due to the widespread occurrence of nitrogen derivatives in nature. Concerning addition reactions to C–N multiple bonds, metalated 1-alkoxy-1,3-dienes behave unusually with respect to 1-lithio-1,3-dienes cited above. In particular, when organonitriles were used as electrophiles they underwent a novel cycloaddition path. Interestingly, the addition-cyclization reaction of organonitriles to alkoxydienyl anion provides an attractive and unconventional method for the preparation of pyrimidines. During this systematic investigation we envisioned that a new three-component synthesis of the pyrimidine ring could be planned on the basis of the disconnection approach shown in Scheme 5, that hints the use of a metalated diene as a nucleophile and of two nitriles as electrophiles (1,6-, 2,3-, and 4,5-bond forming reactions).⁸

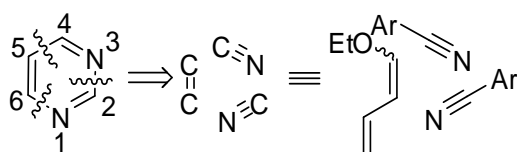

Scheme 5. Disconnection approach for the three component synthesis of pyrimidines

We were especially interested in promoting the trapping of the metalated imine intermediate, that can be in principle be accomplished according to an intra- or intermolecular approach (Scheme 5).

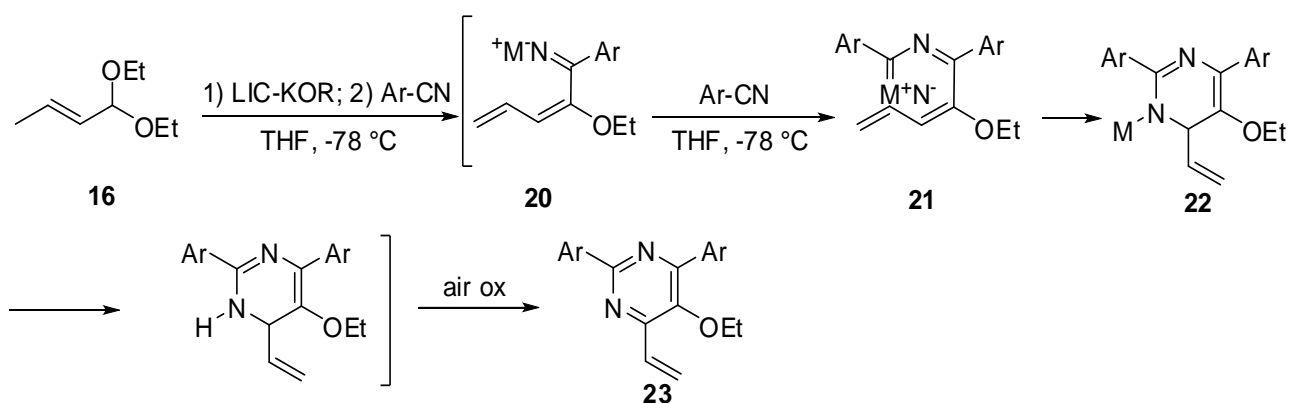

Scheme 6. Proposed mechanism for the synthesis of pyrimidines

When acetal **16** was reacted with 2 equivalents of benzonitrile in THF for 2 h at $-78\text{ }^{\circ}\text{C}$ in the presence of the LIC-KOR base, and then for 2 h at room temperature, 5-ethoxy-2,4-diphenyl-6-vinylpyrimidine (**23**, Ar = Ph) was produced in 80 % yield. As illustrated in Scheme 6, the initially formed *N*-metalketimine **20**, as the temperature increases, adds to a second molecule of organonitrile and gives a new *N*-metalketimine intermediate **21**. Finally, an intramolecular cyclization leads to the metal 5-ethoxy-2,6-diphenyl-4-vinyl-4*H*-pyrimidin-1-ide intermediate (**22**, Ar = Ph) which upon quenching with aqueous NH_4Cl affords pyrimidine **23** via an 6-*endo*-trig cyclization. The synthesis was successfully carried out with aryl nitriles bearing electron donating and electron withdrawing substituents (Scheme 7). In order to tune the reactivity of imine group, the *N*-metalketimine intermediate **20** was trapped with benzoyl chloride, affording **24** that was hydrolyzed with Amberlyst-15 in wet CHCl_3 . Cyclopentenones **25** have been thus obtained in good yields according to an 5-*exo*-trig cyclization as depicted in Scheme 7.

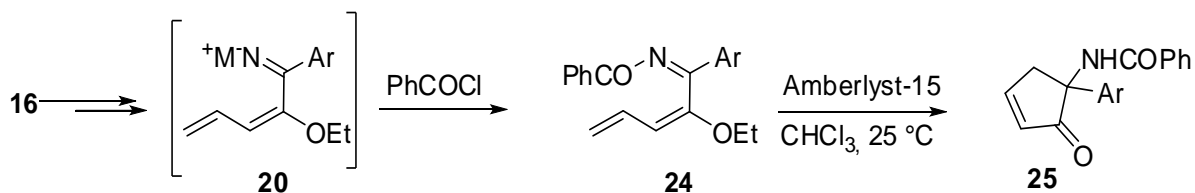

Scheme 7. Synthesis of cyclopentenones

2. 1,3-Enynes: Syntheses and Applications

2.1. Synthesis

1,3-Enyne function can be found in many naturally occurring and biologically active compounds. Several methods are available for the synthesis of enynes, many of which are based on the Pd(0)-catalyzed Sonogashira coupling of aryl or vinyl halides with terminal alkynes. Here, we wish to report the most recent progresses in the stereodefined synthesis of conjugate enynes, gathered according to the synthetic approach followed.

Transition metals mediated cross-couplings. Cross-coupling palladium catalyzed reactions between aryl halides and alkynes have been largely described as valuable synthetic tool for the synthesis of conjugated enynes, **26**, nevertheless their application usually needs harsh conditions and high catalyst loadings. Traditionally, the Sonogashira coupling involves the use of Pd[(PPh₃)₃]₄ associated with CuI. Santelli *et al.*⁹ described the use of the tetraphosphine Tedicyp (tetrakis(diphenylphosphino-methyl)cyclopentane (**27**), (Scheme 8) as a Pd ligand for an efficient Sonogashira type cross-coupling between vinyl bromides **25** and various alkynes, including sterically demanding ones at as little as 0.1 – 000.1% loading.

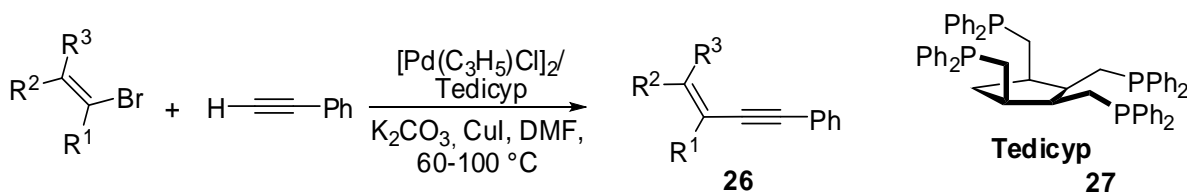

Scheme 8. Cross coupling reactions of vinyl bromides with acetylene

The stereocontrolled synthesis of 1,3-enynes containing heteroatom functional groups has attracted considerable interest in organic synthesis as many useful functional group transformations can be achieved by in introduction and removal of heteroatom functions. Thus, (*E*)-1-arylseleno-substituted 1,3-enynes **28** have been successfully synthesized and coupled in the presence of Ni catalyst with Grignard reagents to afford the correspondent (*E*) enediynes **29** (Scheme 9).¹⁰

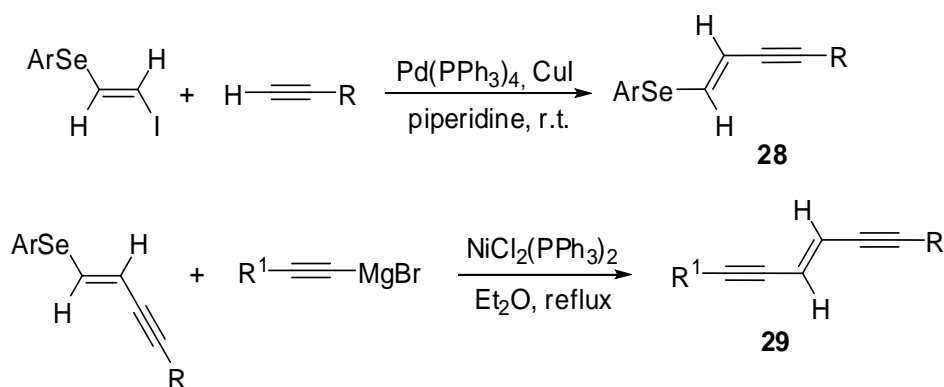

Scheme 9. Synthesis of (*E*)-1,3-diyne

Sulfonyl-substituted 1,3-enynes **32** have been synthesized by Sonogashira coupling reaction of (*E*)- β -iodovinyl sulfones **30** with terminal alkynes **31**.¹¹ The sulfonyl group in the obtained 1,3-enynes can be further removed by desulfonylation coupling with various Grignard reagents. Therefore, the obtained sulfonyl-substituted 1,3-enynes **32** are useful precursors for differently substituted 1,3-enynes **33**.

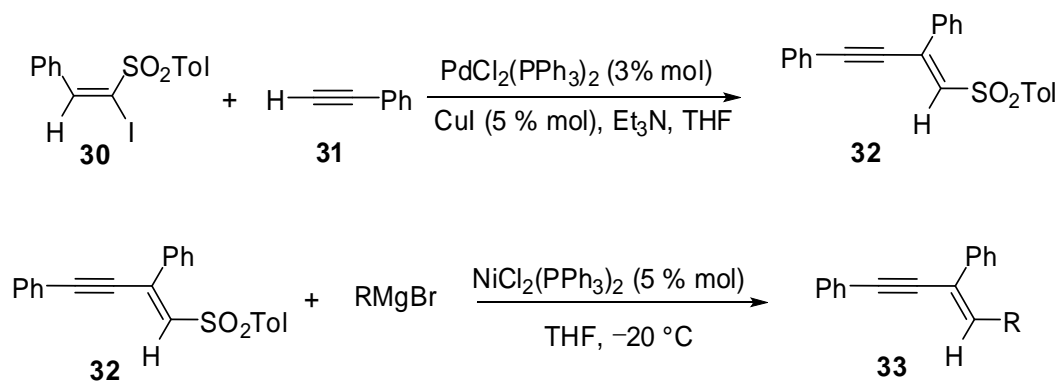

Scheme 10. Coupling of (*E*)-1-iodo-1-phenyl-2-tosylethene with phenylacetylene

Stereodefined *cis*-enynes **37** and **38**, and *trans*-enynols **41** have been successfully obtained starting from conjugated 1,3-butadiynes and aldehydes by titanation mediated by dialkyltitanium¹² (Scheme 11).

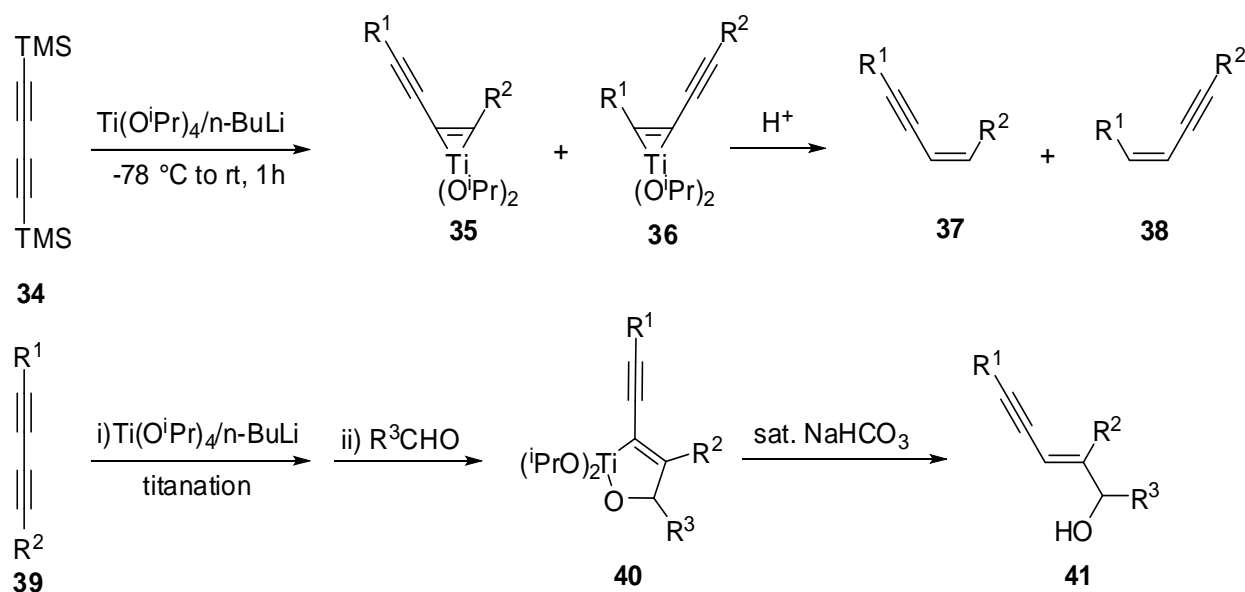

Scheme 11. Selective coupling of conjugated 1,3-butadiynes with aldehydes

The alkoxytitanium-butadiyne complexes **35** and **36** are generated by $\text{Ti(O}^i\text{Pr)}_4/2^n\text{BuLi}$ system. After quenching the mixture with 3N HCl, *cis* enynes **37** and **38** are formed in good yields, thus indicating a selective mono-titanation that occurs under these conditions. Moreover, the Ti(II)-butadiyne complexes **35** and **36** formed *in situ* are valuable intermediates for further transformations. Accordingly, when an aldehyde is added to the reaction mixture, oxatitanacyclopentene **40** forms which upon hydrolysis with NaHCO_3 selectively gives the *trans*-enynol **41**. The coupling reaction could be applied to a variety of aromatic aldehydes with yields from good to high.

Hou *et al.* reported that half-sandwich rare-earth metal alkyl complexes bearing a silylene-linked cyclopentadienylamido ligand served as efficient catalysts for the catalytic dimerization of terminal alkynes to give both *E* or *Z* enynes.¹³ More recently, the same authors found that selective formation of (*Z*)-1-aza-1,3-enynes **42** occurs by reaction of terminal alkynes with isocyanides **43** in the presence of earth metal complexes (**44** e **45**, Scheme 12).¹⁴

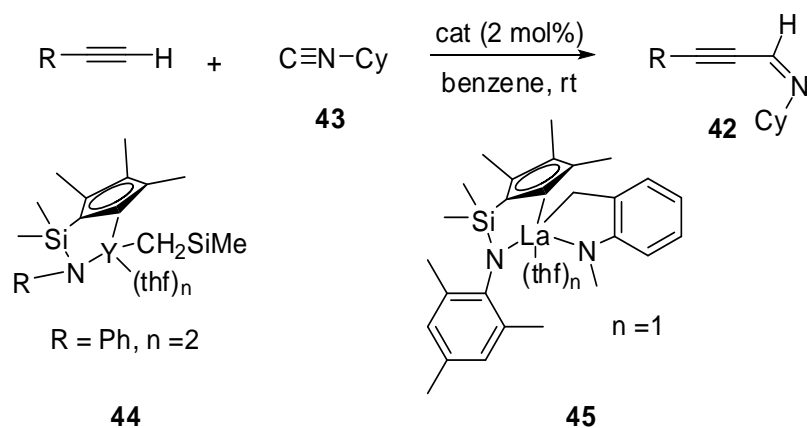

Scheme 12. Rare-earth-metal-catalyzed monoinsertion of cyclohexyl isocyanide into phenylacetylene

This can be considered a worthwhile example of regio- and stereoselective 1 : 1 cross-coupling between a terminal alkyne and isocyanide that exclusively gives the (*Z*)-1-aza-1,3-enyne. The unprecedented *Z* selectivity could arise from formation of an alkyne-bridged binuclear catalyst species, in which the cross-coupling reaction takes place at the two metal centers in an intermolecular fashion (Scheme 13).

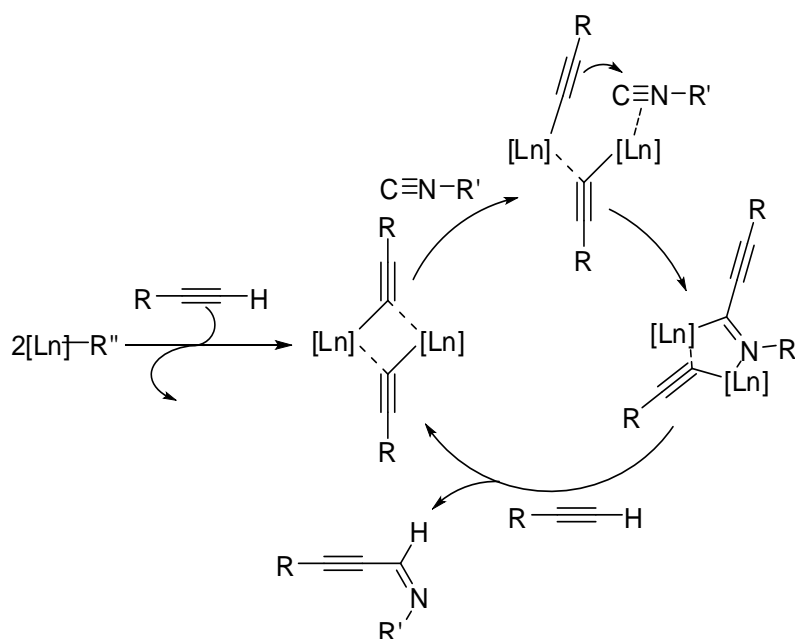

Scheme 13. Proposed catalytic mechanism

2.2. Applications

Various 1,3-enynes and allenols have been obtained from vinylidencyclopropanes.¹⁵ When vinylidencyclopropanes **46** (Scheme 14) are treated with LDA and the reaction is quenched by addition of aldehydes, vinylcyclopropanes **47** have been obtained. With ketones as electrophiles, under controlled experimental conditions, allenole derivatives **48** are formed. Finally, when the addition reaction is carried out using enones, the correspondent 1,3-enyne derivatives **49** can be obtained in good yields.

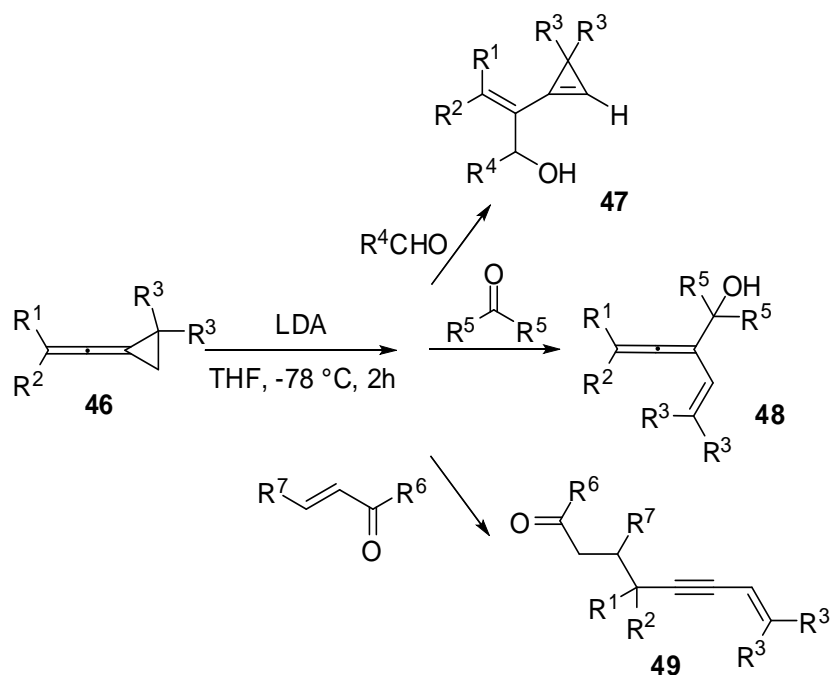

Scheme 14. Reactions of carbanion derived from vinylidencyclopropanes with aldehydes, ketones and enones

An unusual approach to 1,3-conjugated enynes **53** was reported by Satoh *et al.*¹⁶ In that article, the magnesium alkylidene carbenoides **51**, obtained from 1-chlorovinyl *p*-tolyl sulfoxides **50** and Grignard reagents via sulfoxide-magnesium exchange, was reacted with lithium acetylides. As the intermediate of this reaction is thought to be the alkenyl carbanion **52**, the overall sequence could be in principle exploited to get further substituted conjugated enynes by trapping the intermediate with suitable electrophiles. Unfortunately the reaction is limited in scope in that the overall yields are in many cases not satisfactory.

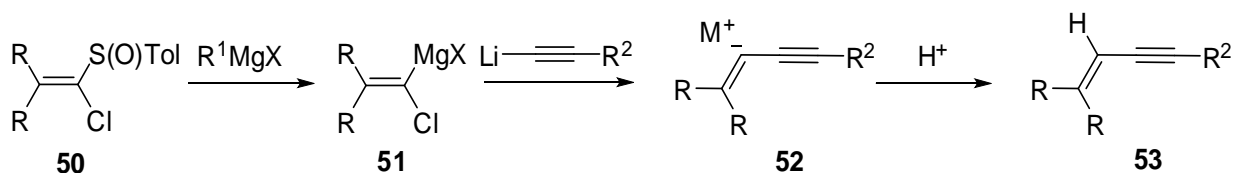

Scheme 15. Synthesis of enynes from alkylidene carbenoids

Propargylic acetals proved to be versatile substrates for the synthesis of 1,3- or 1,2-unsaturated systems.¹⁷ When propargylic acetal **54** is treated with a base, metalation at the propargylic site occurs affording intermediate **55**. At $-85\text{ }^{\circ}\text{C}$ **55** rearranges to metallated allene **56** which, after the addition of a suitable electrophile, gives the functionalized allenic acetal **57** (path a). Alternatively, working at $-78\text{ }^{\circ}\text{C}$, intermediate **55** undergoes conjugated elimination of EtO^- to afford cumulene **58** (path b). Addition of one more equiv of base promotes metallation and rearrangement to metallated (*E*)-4-ethoxybut-3-en-1-yn-1-ide **59** which can be quenched with an electrophile to give functionalized enyne **60**. Finally, a larger excess of base and higher temperatures promote a further β -elimination of EtO^- and the formation of diyne **61**.

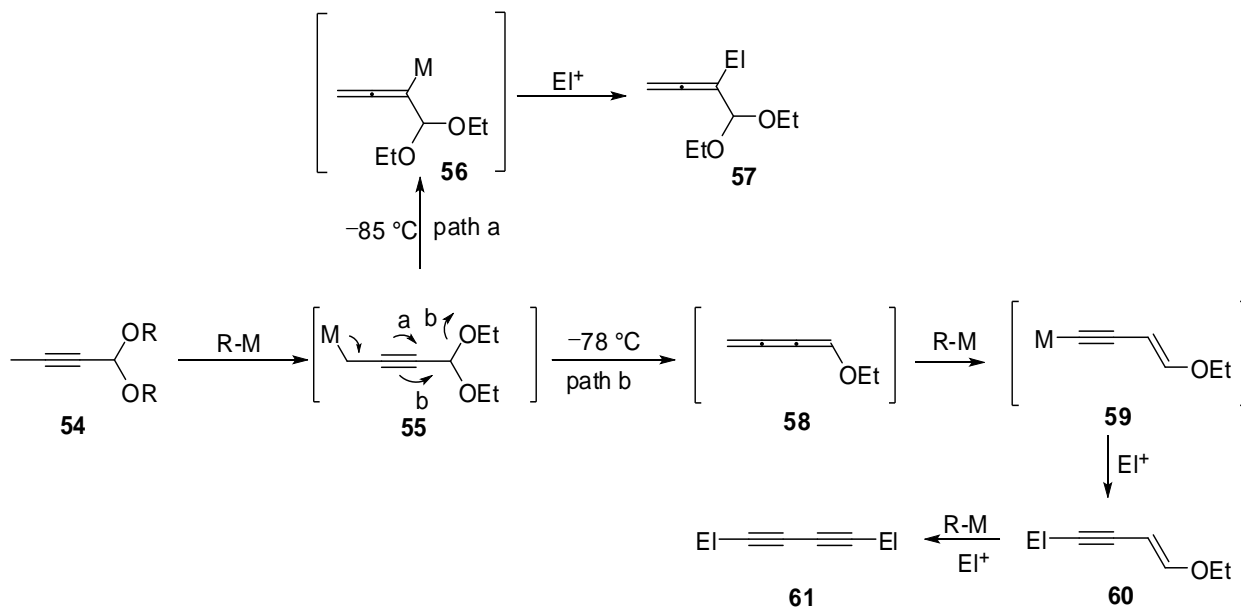

Scheme 16. Base promoted elimination reactions for the synthesis of allenes, enynes and diynes

The general reactivity depicted in Scheme 16 could be selectively oriented to the target compounds (enynes, diynes or allenes) by the choice of a suitable base, so that functionalized *E*-conjugated enynes can be obtained in the presence of LDA, while an excess (3.4 equiv) of superbases LIC-

KOR⁴ (BuLi/*t*-BuOK, 1/1) selectively promotes the synthesis diynes **61**. Moreover, a carefully control of the reaction temperature allows the isolation of allenes **57**.

Besides propargylic acetals, propargylic dithioacetals **62** (Scheme 17), have been recently used for the synthesis of enynes.¹⁸

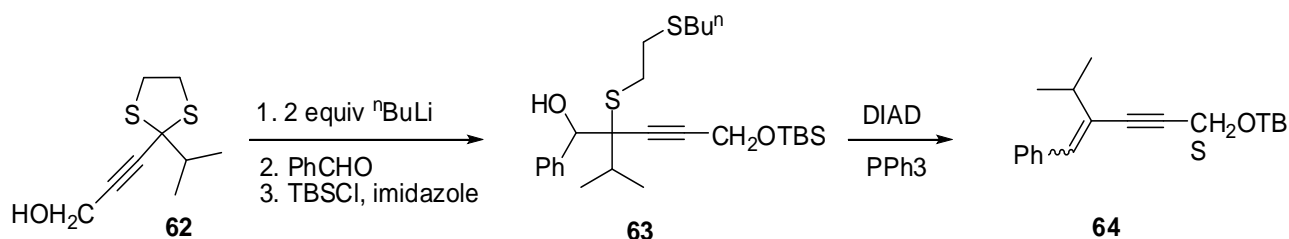

Scheme 17. Synthesis of enynes from dithioacetals

Compound **63** has been obtained from the reaction of **62** with BuLi followed by treatment with PhCHO and then with TBSCl and imidazole. β -Elimination of the hydroxyl-thioether **63** under Mitsunobu conditions gives the corresponding enyne **64**. Generally speaking, it may be plausible that the hydroxyl group in the hydroxyl-thioether would be activated by Ph₃P, giving the intermediate **63a**; the phosphine oxide may serve as leaving group with the concomitant participation of the neighbouring sulphur moiety leading to the formation of episulfonium ion **65** (Scheme 18). Stereoselective extrusion of the sulphur moiety may stereospecifically lead to the corresponding olefin **64a**. It has been observed that a bulky aryl substituent in **63a** would drive the elimination process to the *Z* isomer predominantly.

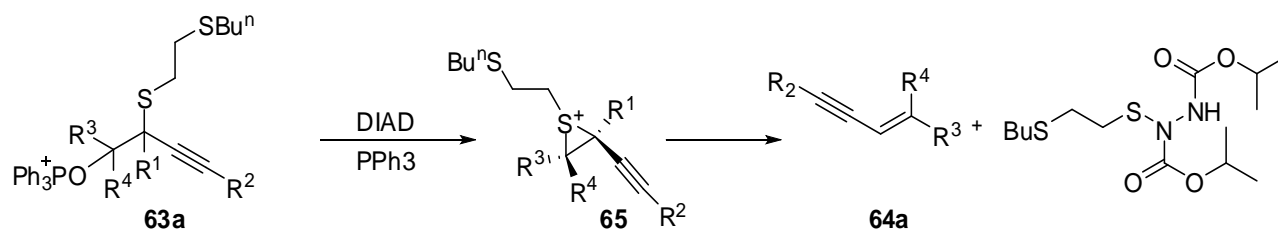

Scheme 18. Possible mechanism for the formation of **64**

Stereodefined 1,3-enynes are generally exploited as substrates for the synthesis of conjugated 1,3-dienes (**68**, Scheme 19). One of these procedures relies on the transition metal-catalyzed reductive

coupling reactions between 1,3-enynes **66** and aldehydes **67** in the presence of a monodentate *P*-chiral ferrocenyl phosphine ligand. (**a** or **b**, Scheme 19).¹⁹

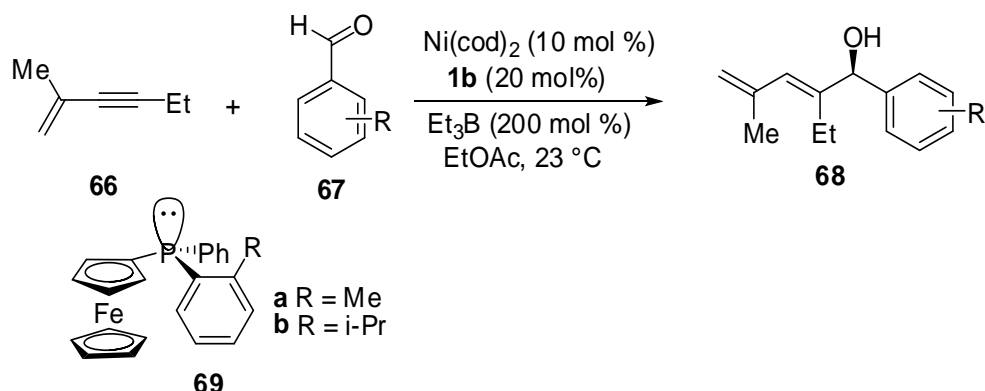

Scheme 19. Catalytic asymmetric reductive coupling of enynes and aromatic aldehydes

The dienols **68** have been recovered with a very high regioselectivity but modest enantioselectivity. The scope of the reaction can be extended to the synthesis of trimethylsilylsubstituted dienols, after protodesilylation under mild conditions synthetically useful 1,3-dienes that can be easily obtained. A similar approach has been proposed by Krische *et al.*²⁰ The authors discovered that hydrogenation of conjugated enynes **69** with heterocyclic aromatic aldehydes or ketones **70** using chirally modified rhodium catalysts (**71** and **72**, Scheme 20) enables direct formation of carbonyl addition products **73** with high level of both regiocontrol and asymmetric induction.

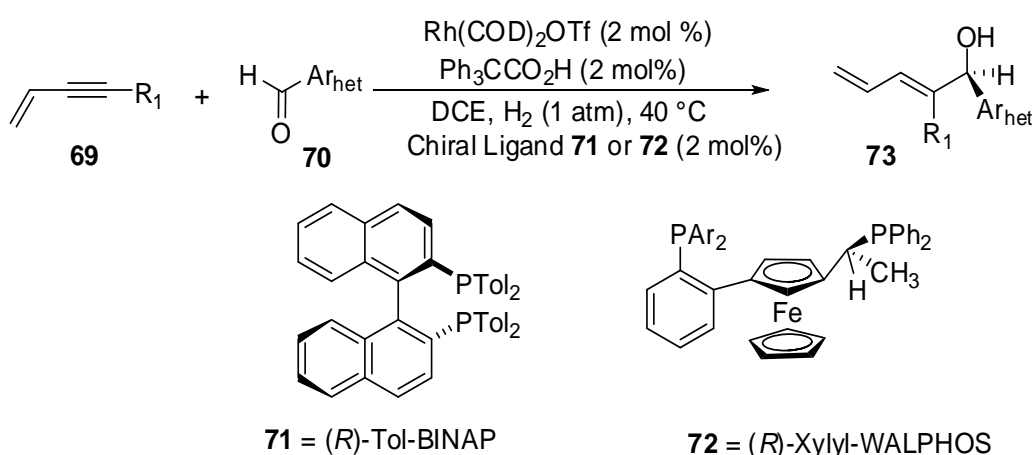

Scheme 20. Enantioselective reductive coupling of 1,3-enynes to heterocyclic aromatic aldehydes and ketones

α -Ethynyl ketene-*S,S*-acetals **74** have been used as substrates for high stereoselective C–C bond forming reactions with aldehydes in the presence of TiCl_4 . (Scheme 21)²¹

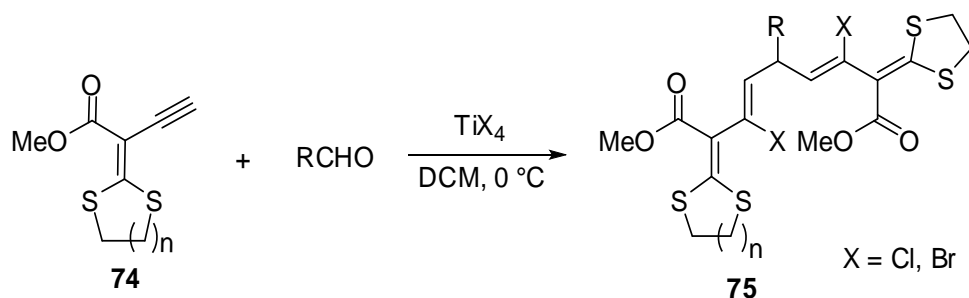

Scheme 21. Conjugated enynes ketene-S,S-acetals with aldehydes

When ketene thioacetal **74** was treated at $0\text{ }^\circ C$ with aldehydes in CH_2Cl_2 in the presence of one equivalent of $TiCl_4$ the (*E,Z*)-3,7-dichloronona-3,6-dienoates **75** were formed in good yields. Unfortunately, under these conditions substoichiometric amounts of $TiCl_4$ gave unsatisfactory results. Compounds **75** can then be easily converted into 3,7-dioxononadioates **76**. (Scheme 22)

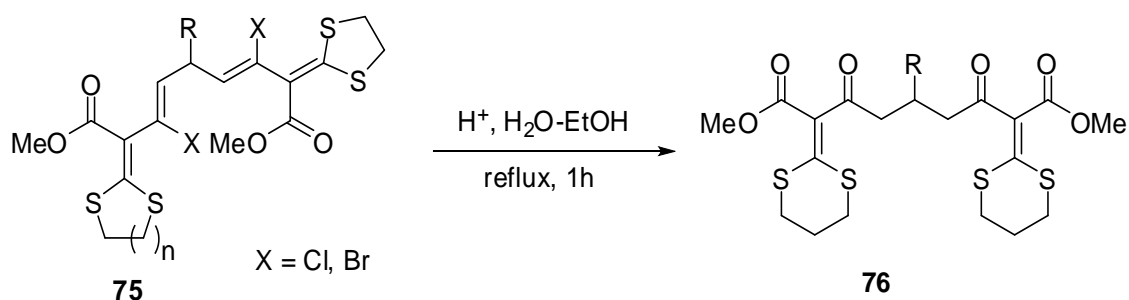

Scheme 22. Acid catalyzed hydrolysis of **75** to **76**

Enynes, prepared according to traditional Pd-catalyzed approach by means of a coupling between the appropriate vinyl and alkynes derivatives, were subjected to metal catalysed silaboration using 2-(dimethylphenylsilyl)-4,4,5,5-tetramethyl-1,3,2-dioxaborolane **77** (Scheme 23).²²

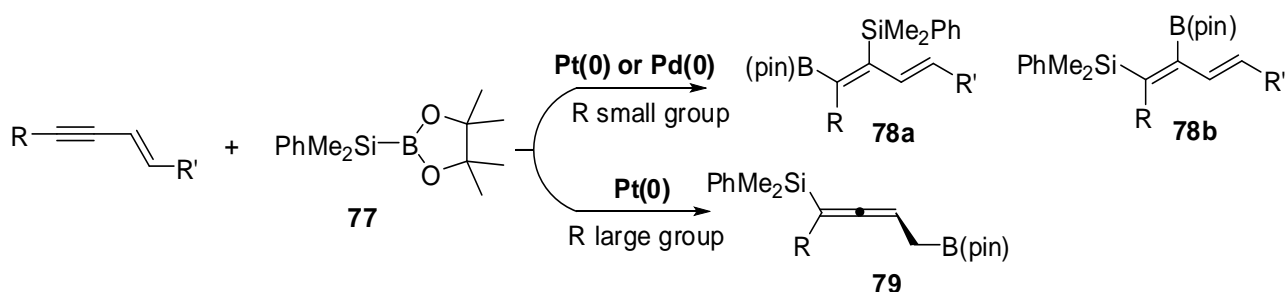

Scheme 23. Silaboration of enynes

Depending on the structure of the substrate and on the experimental conditions, the reaction leads either to stereo- and regiochemically defined 1,3-dienes **78** or to allene **79** respectively according to

a 1,2- or 1,4-addition process. Vinylsilanes and vinylboranes functions on 1,3-dienes as well as allylboranes and vinylsilanes on allenes can be thus introduced. The 1,4-addition is limited to substrates containing bulky substituents in the 1-position and non substituents in the 4-position.

1,1-Diaryllallenes **80** or 1,3-diaryllallenes **81** have been synthesized starting from enynes.²³

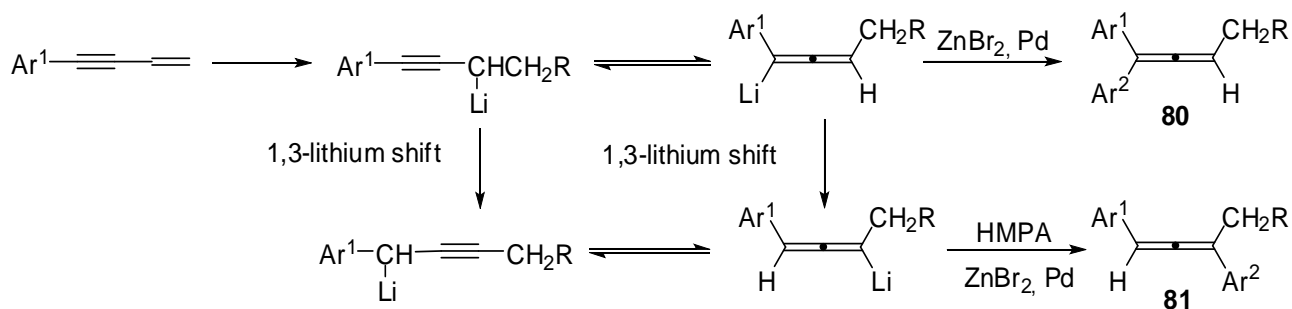

Scheme 24. Synthesis of 1,2- and 1,3-allenes from enynes

The 1,3-lithium shift in propargylic/allenyl species formed from conjugate addition of organolithium derivatives to enynes, can be controlled. Subsequent transmetalation and Pd(0) cross coupling with aryl halides afforded allenes **80** and **81**. A new approach toward allylic and propargylic hydrazines based on the cobalt-catalyzed hydrohydrazination reaction of dienes and enynes have recently been proposed.²⁴ For dienes, allylic hydrazines have been obtained with useful yields and regioselectivities. For enynes **82**, the selective amination of the double bond is unprecedented and opens a new perspective for the selective functionalization of enynes, a route to propargylic hydrazines **83** as useful building block in the synthesis of biologically active compounds. (Scheme 25)

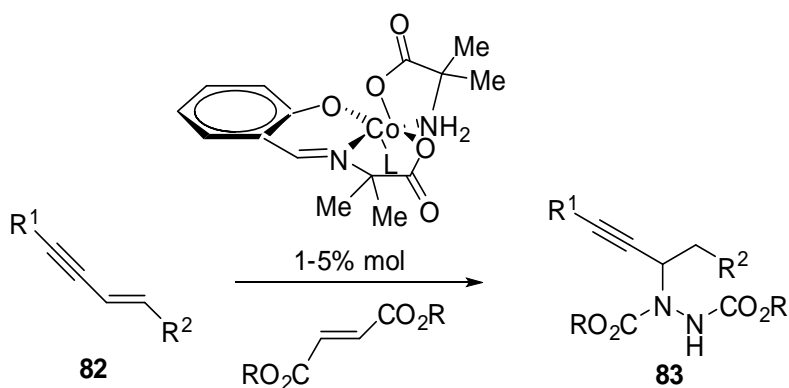

Scheme 25. Hydrohydrazination of conjugated olefins

3. Syntheses of Quinoline and Chromenone Framework

Organic molecules containing C–N and C–O bonds are of significant importance and frequently show interesting properties as pharmaceutically and biologically active substances, dyes and fine chemicals. Many of these significant products, commercialized or in the development phase, can be assembled by organometallic catalyst cross-coupling reactions. Among these quinolines and their derivatives have long been developed as antimalarial agents, since the discovery of cinchona alkaloids. Chromenone derivatives are as well widely distributed in nature, and the chromenone system, is a common motif found in a variety of natural products, and is used as a versatile intermediate in organic and natural product synthesis. Moreover, also this class of compound is reported to have various biological activities, such as antimalarial, antibacterial, anticoagulant and anti-HIV activities. Consequently, the development of an efficient synthesis to obtain these valuable compounds has attracted the interest and the efforts of various laboratories of organic synthesis. We wish to report herein an expeditious synthesis we recently realized exploiting the versatile ethoxydienyl moiety as building block. Furthermore, in order to properly evaluate our synthetical approach we included the most reliable syntheses of chromene and quinoline skeleton that have recently appeared in the literature.

3.1 Quinoline and Chromenones from Alkoxy-1,3-Dienes

In the course of recent studies, we have described a new synthesis of quinoline and chromene systems,²⁵ that starts from alkoxy-functionalized butadienylboronic esters **84**. These derivatives have been primarily synthesized starting from α,β -unsaturated acetals **16** through intermediate **84**, and then cross-coupled with both *N*-protected and *N*-unprotected 2-bromo and 2-iodoaniline, and with 2-iodophenol. In particular, *N*-tosyl-protected dienyilanilines were transformed under mild conditions into quinolines **85** and quinolinones, in the presence of a Pd^{II} catalyst (Scheme 26).

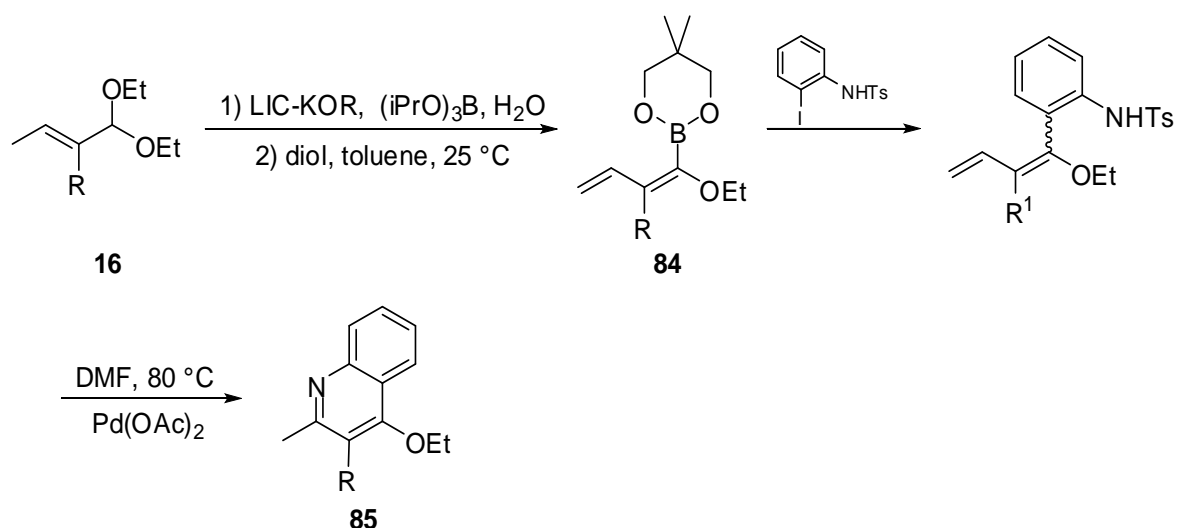

Scheme 26. Synthesis of quinolines starting from α,β -unsaturated acetals

Moreover, the cross-coupling reaction between butadienylboronic esters and iodophenol directly affords chromenes **86** that can be successively transformed into chromenones **87** (Scheme 27).

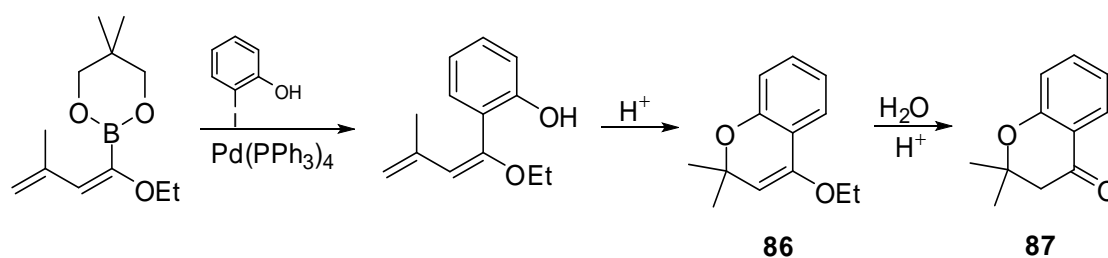

Scheme 27. Synthesis of chromenes and chromenones starting from α,β -unsaturated acetals

Two efficient syntheses of variously substituted 3-(hydroxymethyl)-4*H*-chromen-4-ones (**92** and **93**) has been reported by J. Bolós and co-workers.²⁶ Both synthetic strategies start from 2-hydroxyacetophenone (**88**): the first exploit its conversion to of 4-oxo-4*H*-chromene-3-carbaldehyde (**89**), and the subsequent reduction to the corresponding alcohol **90**, the second one use the condensation of formaldehyde with the previously prepared 2-sulfinyl-1-(2-hydroxyphenyl)ethanone **91** (Scheme 28).

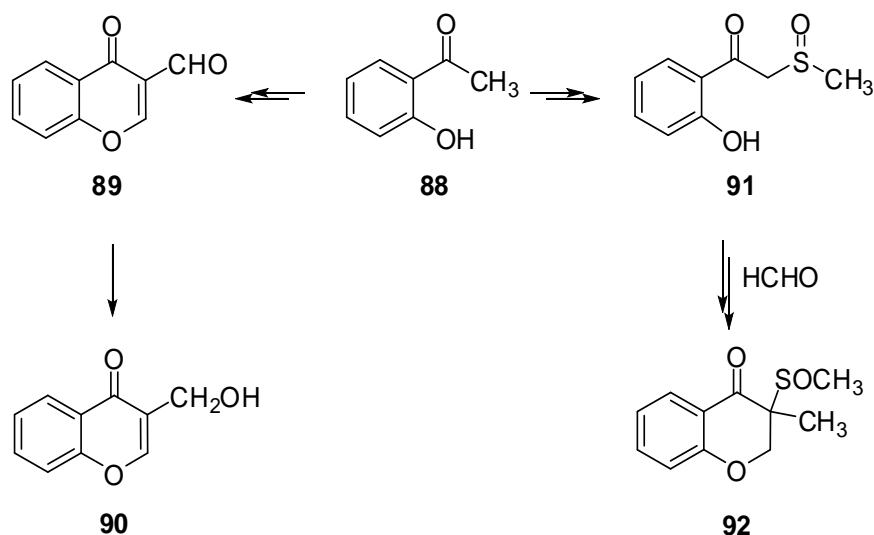

Scheme 28. Synthesis of and chromenones starting from 2-hydroxyacetophenone

M. Bulut, and co-workers have reported the syntheses of 7,8-dihydroxy-3-(3,4-dimethoxyphenyl)-2*H*-chromenones, 7,8-dihydroxy-3-(3,5-dimethoxyphenyl)-2*H*-chromenones and 7,8-dihydroxy-3-(3,4,5-trimethoxyphenyl)-2*H*-chromenones **93**, from 2,3,4-trihydroxybenzaldehyde **92** and the suitable methoxyphenylacetic acid in NaOAc/Ac₂O. 3-Methoxyphenyl-7,8-dihydroxy-2*H*-chromenone reacted with the polyethylene glycol ditosylate or dichloride in CH₃CN/alkali carbonate to afford [12]crown-4, [15]crown-5 and [18]crown-6-chromenones **94** (Scheme 29).²⁷

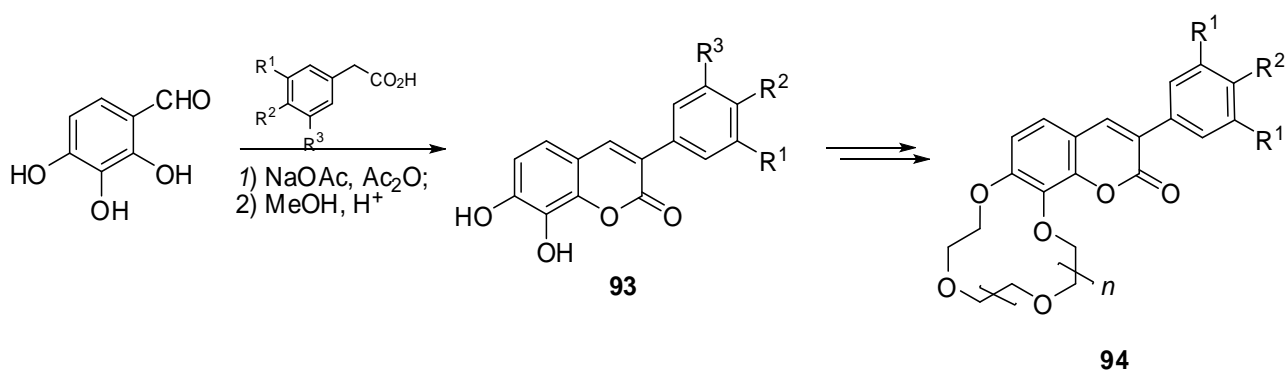

Scheme 29. Synthesis of crown-chromenones

Employing Suzuki–Miyaura palladium catalysed cross-coupling reactions, R. J. Griffin and collaborators, starting from a common chromen-4-one scaffold, have proposed the synthesis of variously substituted 8-biarylchromen-4-ones, in order to achieve new libraries of inhibitors of the DNA-dependent protein kinase (DNA-PK). 2-Morpholino-8-(3-(thiophen-2-yl)phenyl)-4*H*-

chromen-4-one **95** and 2-morpholino-8-(3-(thiophen-3-yl)phenyl)-4*H*-chromen-4-one **96** turned out especially potent (Figure 2).²⁸

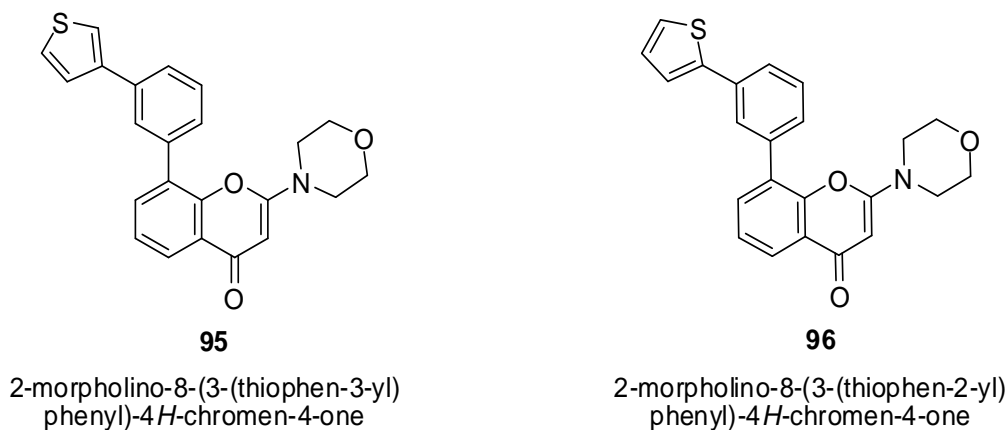
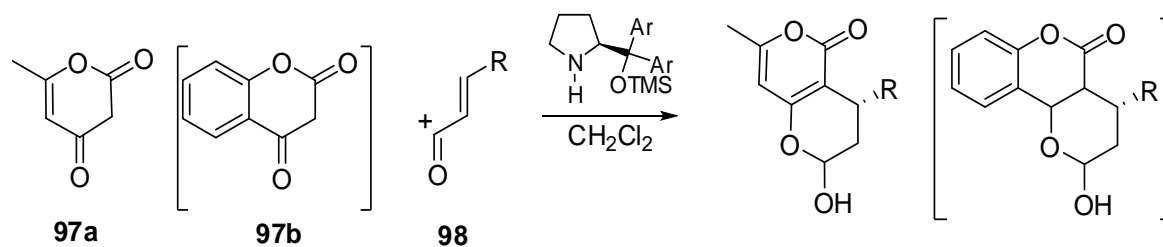

Figure 2

The development of a new asymmetric, organocatalytic procedure for the synthesis of chromenones, quinolinones, and pyranones starting from readily available cyclic 1,3-dicarbonyl compounds **97** and α,β -unsaturated aldehydes **98** has been reported by M. Rueping and collaborators (Scheme 30).²⁹



Scheme 30. Synthesis of chromenones, quinolinones, and pyranones starting from cyclic 1,3-dicarbonyl compounds and α,β -unsaturated aldehydes

M. Schlosser and M. Marull, have verified that the acid-catalyzed cyclization-condensation between anilines **99** and ethyl 4,4,4-trifluoroacetoacetate **100** affords 1,4-dihydro-2-trifluoromethyl-4*H*-quinolinones **101**, which can easily be converted into 4-bromo-2-(trifluoromethyl)-quinolines **102**.³⁰ The synthetic procedure is shown in Scheme 31 and 32.

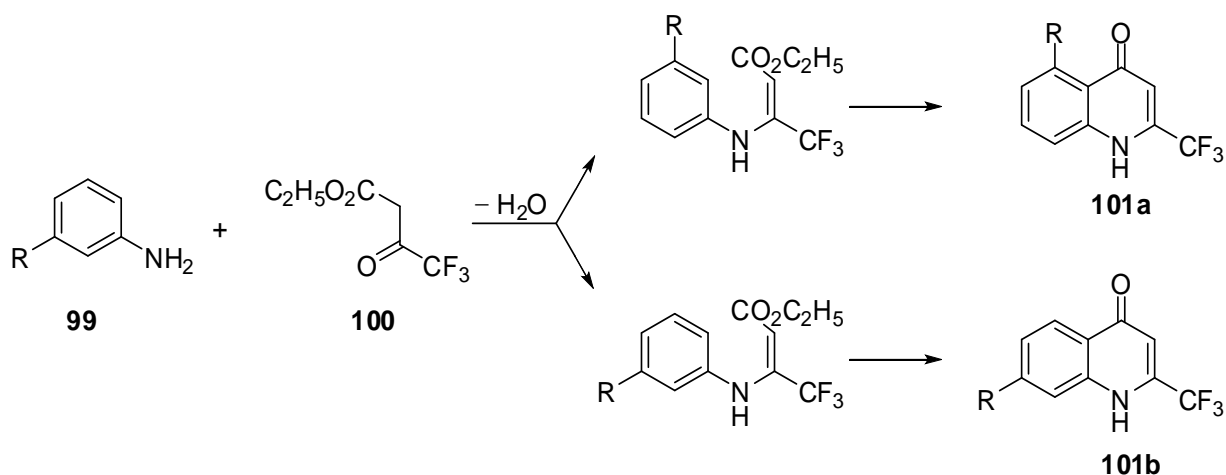

Scheme 31. Acid-catalyzed cyclization-condensation between anilines and ethyl 4,4,4-trifluoroacetoacetate to 1,4-dihydro-2-trifluoromethyl-4*H*-4-quinolinones

In the same paper the authors show that derivatives **102** undergo to halogen-metal exchange, (by treatment with butyllithium), or to hydrogen/metal exchange (by treatment with lithium diisopropylamide), affording the two consequent lithium derivatives **103** and **104**. Trapping of these intermediates provides functionalized products **105** and **106**, respectively. In Scheme 32 a typical example is shown.

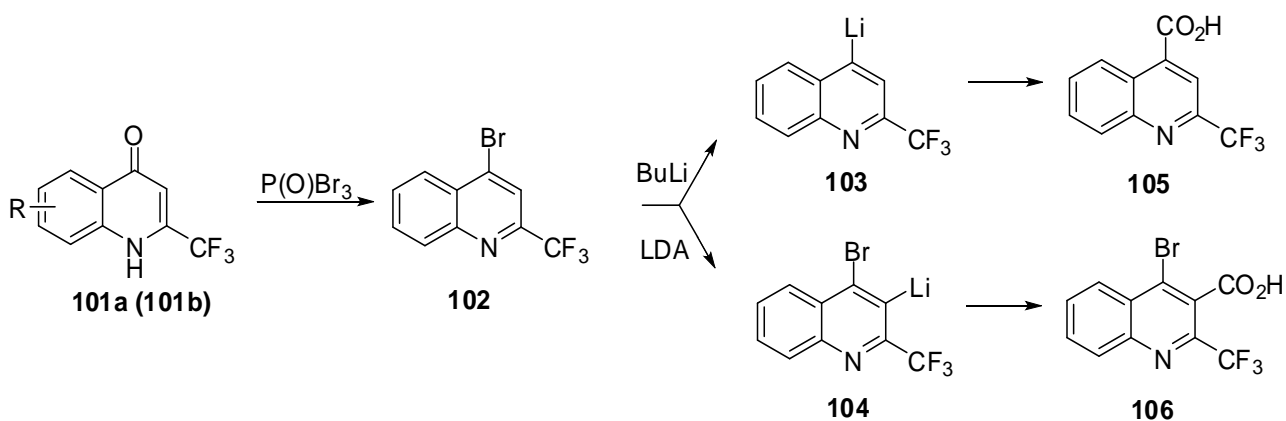

Scheme 32. Synthesis of 4-bromo-2-(trifluoromethyl)-quinolines

A very similar procedure have been used for the preparation of 4-trifluoromethyl-2-quinolinones **107** and quinolines (Scheme 33).³¹

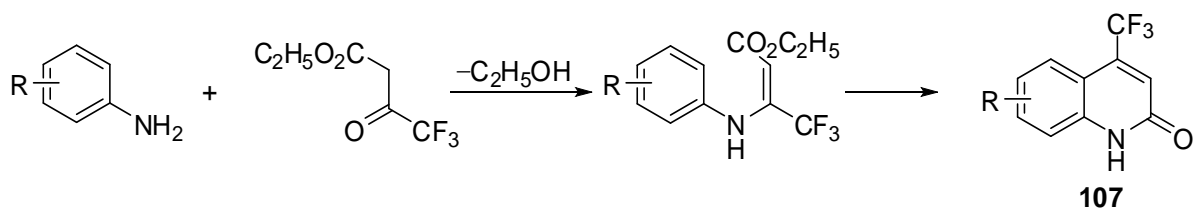

Scheme 33. Synthesis of 4-trifluoromethyl-2-quinolinones

Studies by both R. C. Larock and co-workers and by the group of B. L. Flynn have indicated that 5-*endo*-digonal iodocyclization of alkyl(2-alkynylphenyl) sulphides **108** results an effective method for constructing benzo[*b*] thiophenes **109** as shown in Scheme 34.³²⁻³⁴

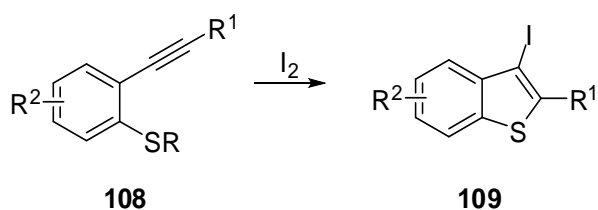

Scheme 34. Iodocyclization of alkyl(2-alkynylphenyl) sulphides to benzo[*b*] thiophenes

Alkynylanilines **110** have been obtained more recently by Flynn and colleagues by extending the tether between the phenyl group and the alkyne (Scheme 35), and have been utilized for the synthesis of quinolines **111** and indoles **112**. The resulting substrates exhibit different *endo/exo* selectivity, not predicted by the Baldwin's rules (Scheme 36).³⁵

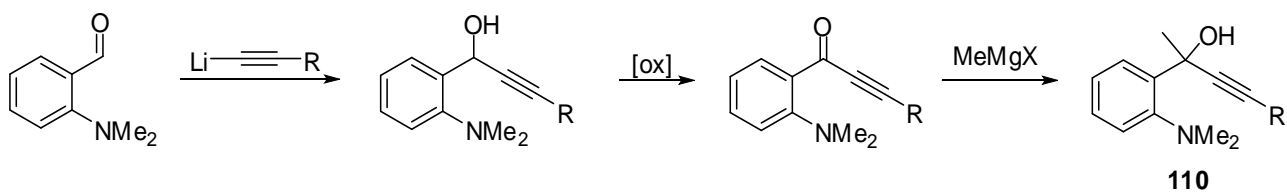

Scheme 35. Synthesis of alkynylanilines

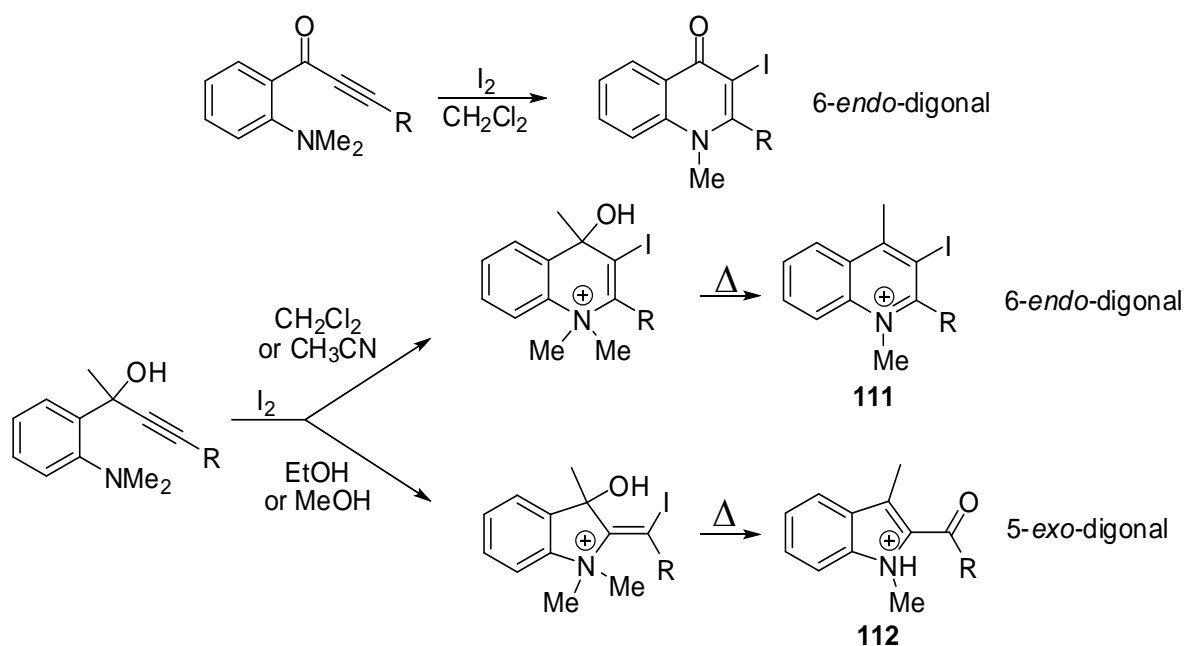

Scheme 36. Synthesis of quinolines and indoles

S. T. Selvi and co-workers have presented a new microwave-induced synthesis of some quinoline alkaloids **113** of the type 4-methoxy-1-methyl-2-quinolinone including folimine. The precursors derivatives were prepared in a single step from aniline and diethylmalonate using *p*-TsOH as a catalyst (Scheme 37), and were converted to the titled quinolines alkaloids **113** by treatment with $(\text{MeO})_2\text{SO}_2$, DMF, and K_2CO_3 (Scheme 38).³⁶

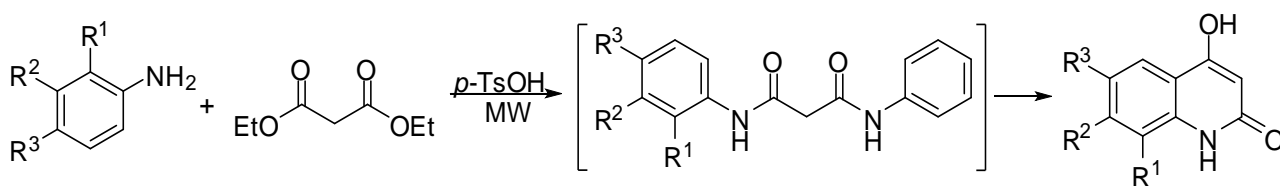

Scheme 37 Synthesis of the precursors of the quinoline alkaloids

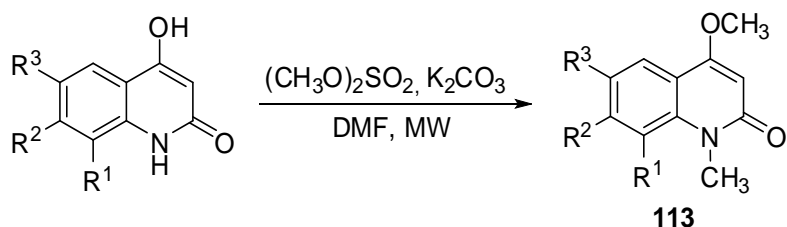

Scheme 38. Synthesis of quinoline alkaloids of the type 4-methoxy-1-methyl-2-quinolinone

A direct synthesis of poly-substituted indeno[1,2-*b*]quinolines **116** assisted by *p*-TsOH and microwave, have been also described by S. J. Tu and co-workers.³⁷ The synthetic route is reported in Scheme 39. The construction of the indeno[1,2-*b*]quinolines scaffold has been accomplished both in AcOH and in aqueous media in the presence of a acidic catalyst (*p*-TsOH).

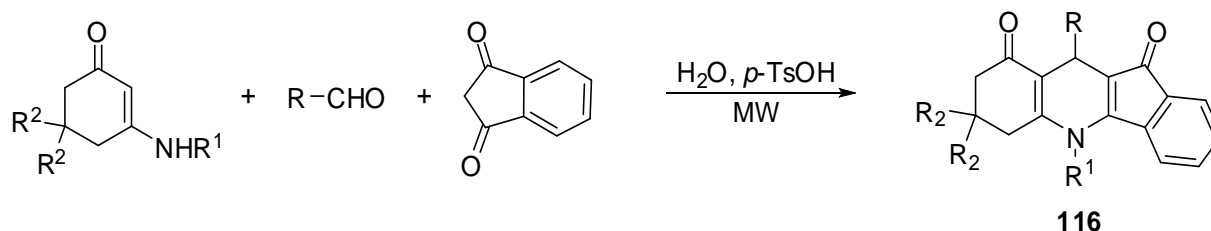

Scheme 39. Synthesis of poly-substituted indeno[1,2-*b*]quinolines

The formation of the target compounds is likely to proceed via initial condensation of aldehydes with 1,3-indanedione **114** to afford 2-arylideneindene-1,3-dione **115**, which further undergoes *in situ* Michael addition reaction with enaminones to yield products **116** (Scheme 40).

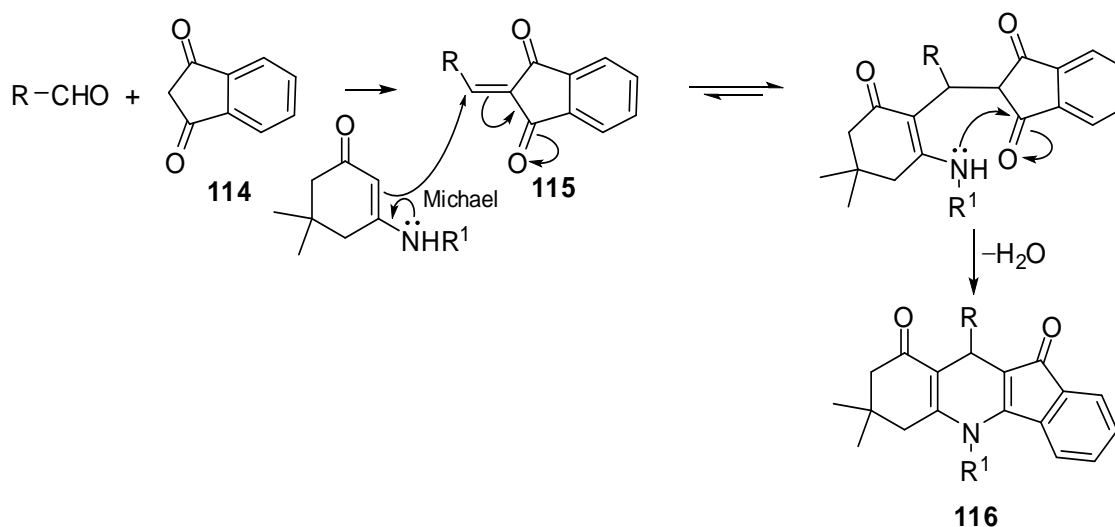

Scheme 40. Proposed mechanism for the synthesis of indeno[1,2-*b*]quinolines

N. C. Chang and C. C. Huang have developed a one-pot procedure which converts *N*-benzyl protected substituted glutarimides **117** to the corresponding ene lactams **118**, and have successively applied such a procedure to the synthesis of *exo*-diene lactams. Diels–Alder cyclization of these

intermediates with dienophiles and then aromatization of the resulting products **119** give 2-quinolinones **120** (Scheme 41).³⁸

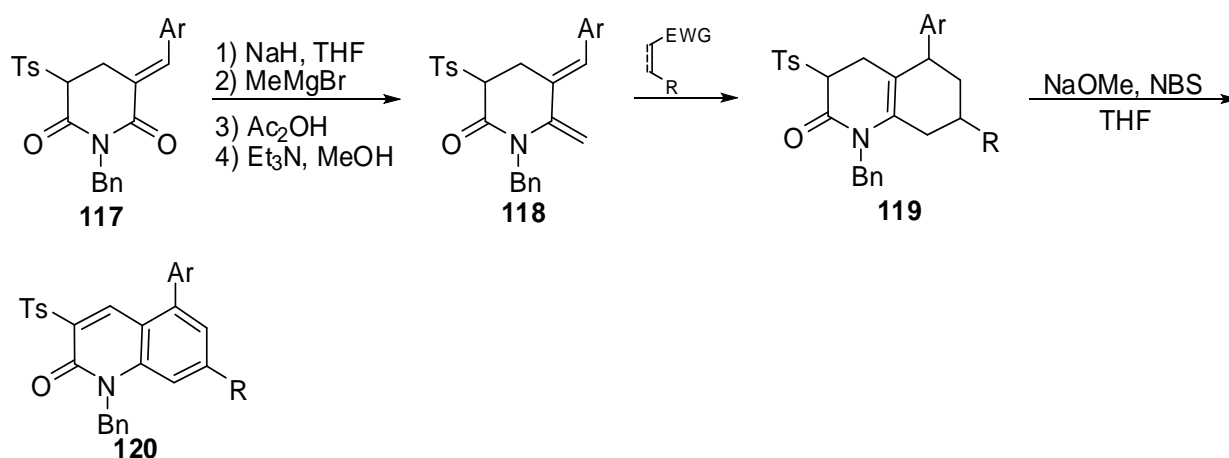

Scheme 41. Conversion of *N*-benzyl protected substituted glutarimides to 2-quinolinones

The synthesis of 2-perfluoroalkyl substituted quinolines **123** using mild reaction conditions has been reported by P. R. Likhar and colleagues.³⁹ The synthesis was carried out via iodocyclization of perfluoroalkyl propargyl imines **121** with I_2 -(NH_4) $_2$ Ce(NO_3) $_6$ (CAN), or involved iodocyclization of perfluoroalkyl propargyl amines **122** using I_2 or ICl and $NaHCO_3$ (Scheme 42).

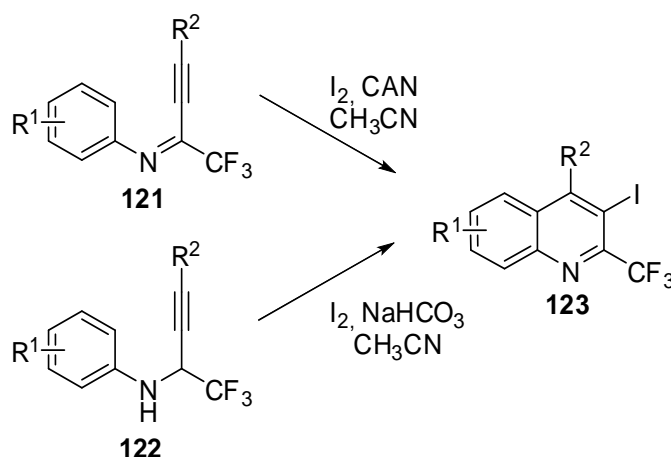

Scheme 42 Synthesis of 2-perfluoroalkyl substituted quinolines

The perfluoroalkyl propargyl **121** imines and amines **122** have been prepared via Sonogashira coupling of easily accessible imidoyl iodides **124** with alkynes; the corresponding amines **122** by subsequent reduction with $NaBH_3CN$ (Scheme 43).

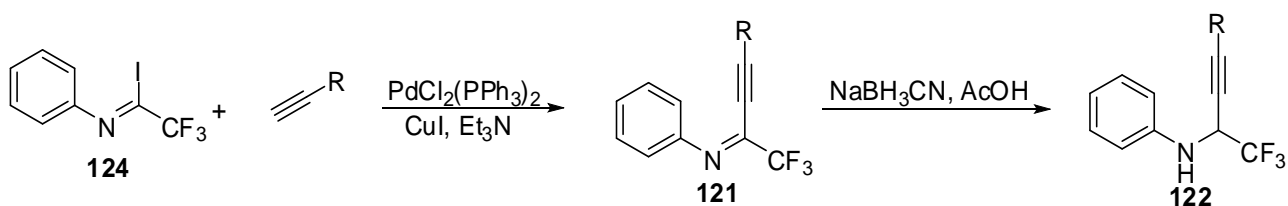

Scheme 43. Synthesis of perfluoroalkyl propargyl imines and amines

The scope of this methodology was also extended by using the resulting 2-perfluoroalkyl-3-iodo quinolines **125** in Suzuki **126**, annulation **127**, dehalogenation **128** and carboxylation **129** reactions (Scheme 44).

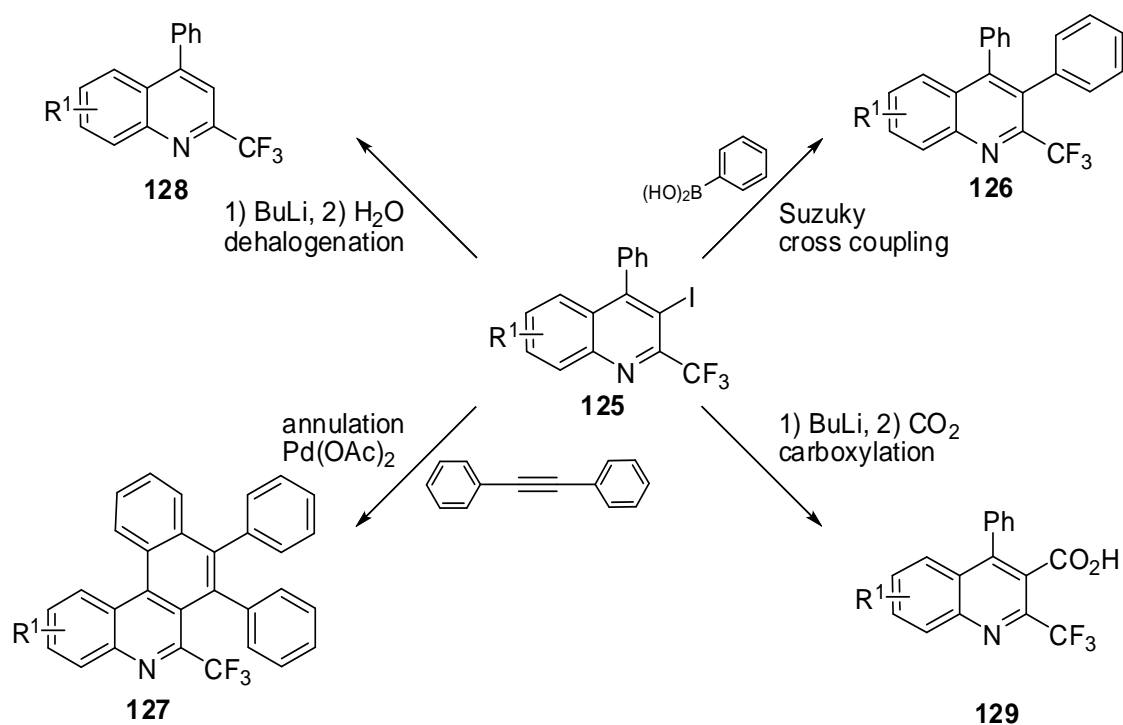

Scheme 44. Synthetic uses of 2-perfluoroalkyl-3-iodo quinolines

V. Mamane and co-workers have reported a general method for the synthesis of all four benzo- (*iso*)quinoline isomers **132**,⁴⁰ that involves a two-step process: 1) a Pd-catalyzed cross-coupling reaction (Suzuki or Negishi) connects the pyridine **130** and the aryl moieties **131**, and 2) a base-promoted cyclization assembles the central ring. This convergent strategy makes possible the introduction of substituents on each cycle of the benzoquinoline core, due to the straightforward metalation of the methyl group of picolines.

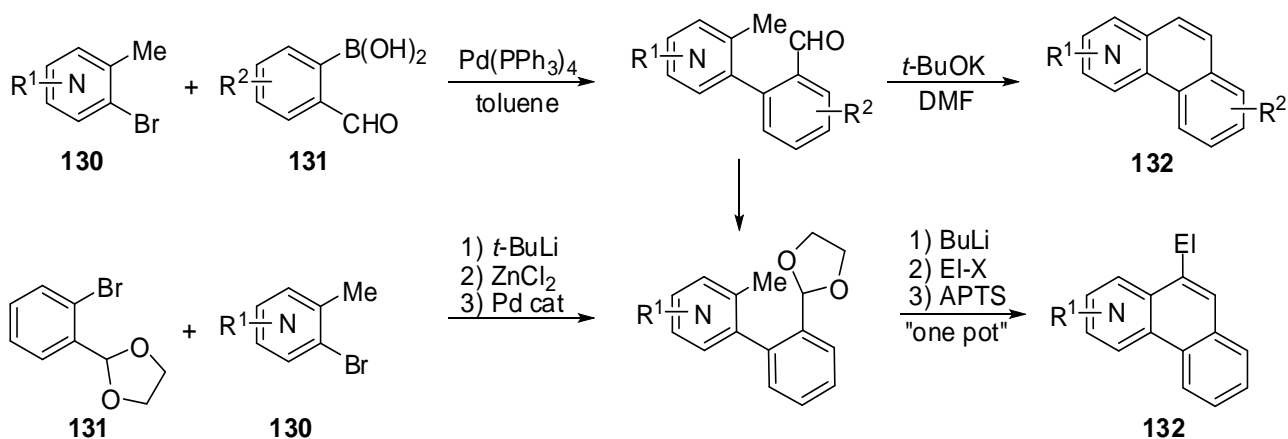

APTS = aminopyrene trisulfonic acid

Scheme 45. Synthesis of benzo-(*iso*)quinoline isomers

4. Pd Catalyzed Reactions of 1,3- and 1,2-Dienes.

4.1. Heck Reaction

In the past two decades, the study of the synthesis and the use of allene derivatives has rapidly been expanded in preparative organic chemistry. As far as Heck couplings are concerned, allenes undergo facile carbopalladation and are widely used in organic synthesis.

A lot of work has been done on Palladium catalyzed polycomponent anion capture cascade processes by Ronald Grigg and his staff. They explored the reactivity of allenes using a non phosphine palladacycle catalyst **133** (Scheme 46), a series of 8-methyl quinoline based dimeric palladacycles containing an sp^3 C-Pd bond, were also developed. Furthermore, Pd-In diastereoselective cascade allylation of imines starting from allenes and aryl iodides was described.⁴¹

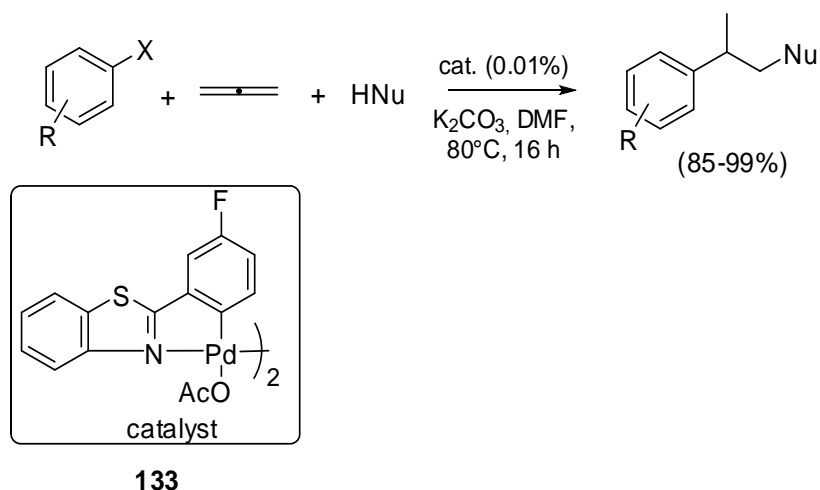

Scheme 46. Reactivity of allenes using a non phosphine palladacycle catalyst

Moreover, an intramolecular version of this reaction has been proposed by the same group. The cascade process was initiated by oxidative addition of Pd(0) into an Ar-I bond and followed by an *exo-trig* (Scheme 47, pathway A) or an *exo-dig* cyclization (Scheme 47, pathway B). Spiro fused ring **134** and bicyclic lactams **135** are respectively obtained.⁴²

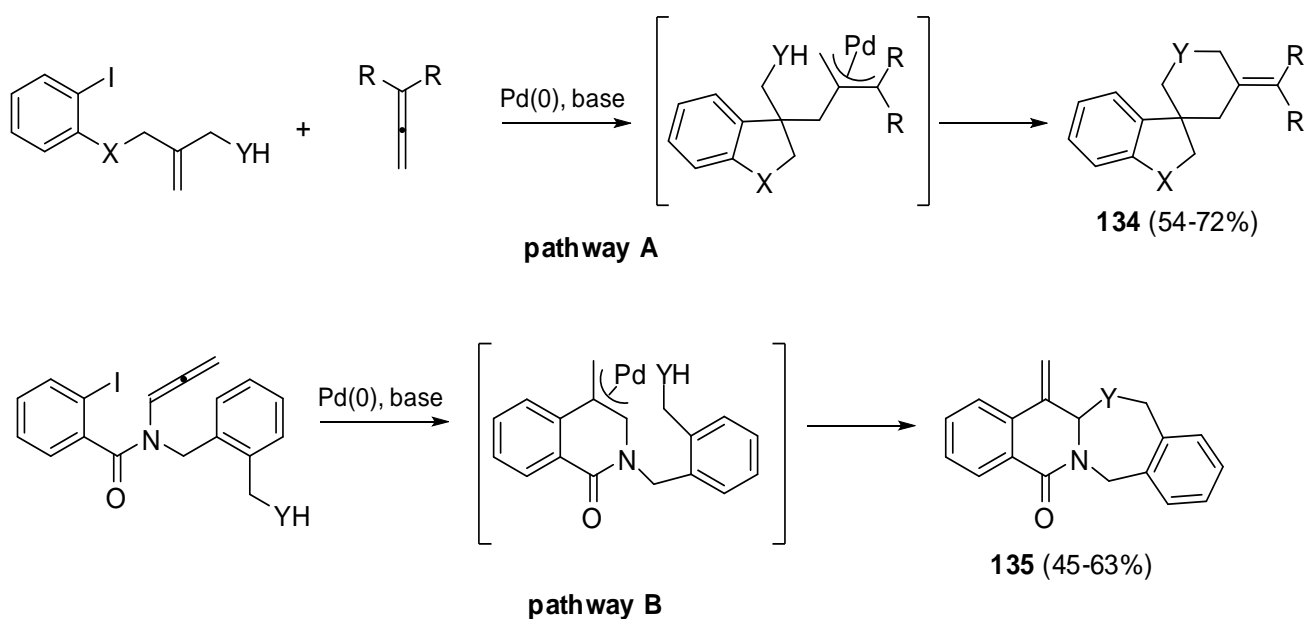

Scheme 47. Intramolecular version of reaction of allenes using a non phosphine palladacycle catalyst

Allenes were involved in a three component (alkyl allene, aryl iodide, *N*-methylmaleimide) intermolecular Heck–Diels–Alder cascade. Best reaction conditions were found to depend on substituents present in the aryl iodide. When electron withdrawing groups are present, higher

temperature are needed in comparison with electron donating substituents. This is probably due to the reduced stability of the ArPdI complex (Scheme 48).⁴³

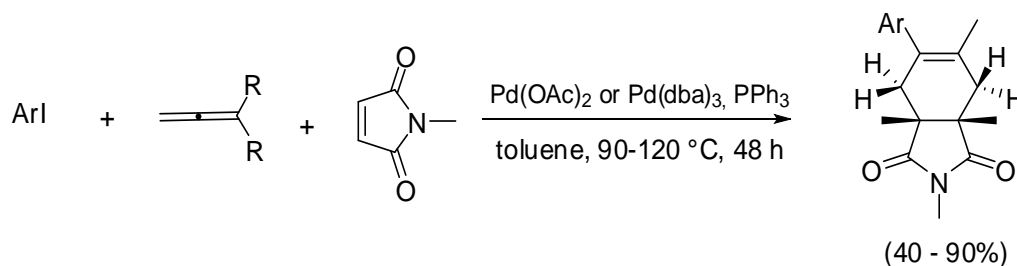

Scheme 48. Three component intermolecular Heck–Dies–Alder cascade

Finally a palladium catalyzed four component process involving carbon monoxide, allene and aryl/heteroaryl iodides was described. The (π -allyl) palladium species so formed were intercepted by alkene tethered nitrogen nucleophiles to afford 1,6- and 1,7-dienones **136**. *N*-heterocyclic enones were afforded by a subsequent ring closing metathesis (Scheme 49).⁴⁴

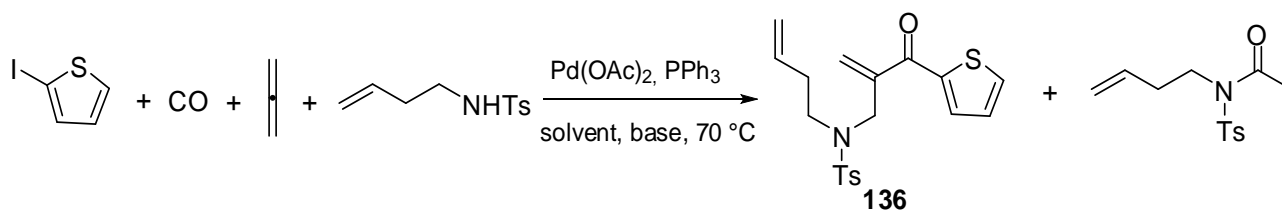

Scheme 49. Four component coupling process to afford 1,6- and 1,7-dienones

1,3-Dicyclopropyl-1,2-propadiene was coupled to various aryl halides, and the 1,3,5-hexatrienes **137** produced after a very fast cyclopropylcarbinyl to homoallyl rearrangement, were trapped with different dienophiles in a domino Heck Diels–Alder reaction.⁴⁵ The synthesis, proposed by de Meijeere *et al.*, was extended to several cyclopropylallenes and yielded oligosubstituted cyclohexene derivatives **138** (Scheme 50). Surprisingly, the [4 + 2] cycloaddition was found to proceed in a non-concerted fashion with a preference for the thermodynamically more stable *trans*, *trans* isomer which cannot be formed in a concerted Diels–Alder reaction.

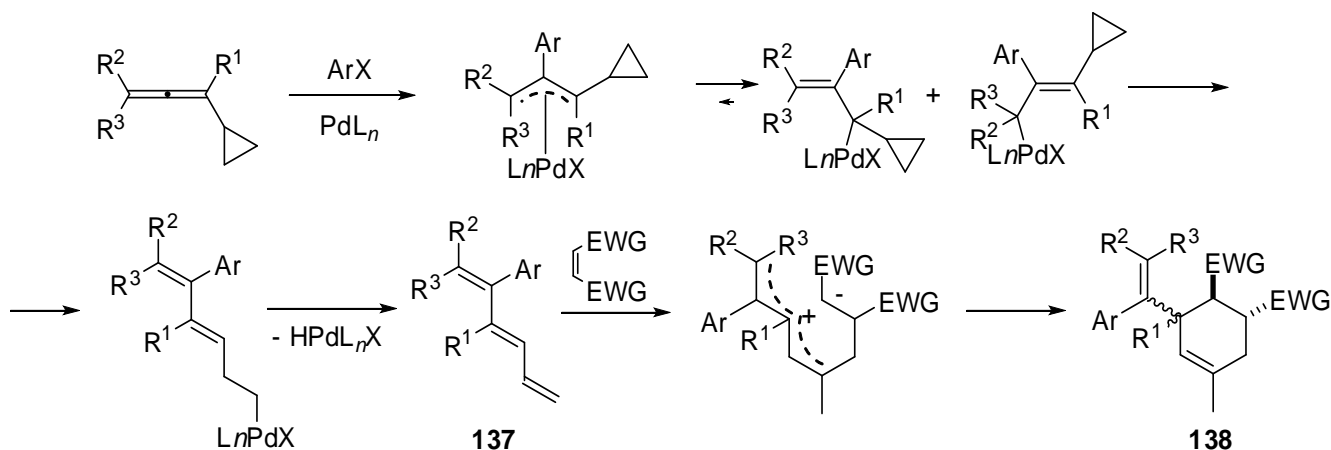

Scheme 50. 1,3-Dicyclopropyl-1,2-propadiene domino Heck Diels–Alder reaction

The reaction between nitrogen and oxygen substituted allenes and aryl iodides or vinyl halides was used to obtain functionalized condensed heterocycles **139** in a regioselective manner by Sakamoto and co-workers. A palladium-catalyzed annulation process was exploited. The nucleophilic attack occurred only at the α position relative to the heteroatom, regardless of the steric encumbrance of the allene substituent. This regioselectivity could be due either to the electronegativity of the heteroatom or to the elimination of the Pd complex with the assistance of the heteroatom (Scheme 51).⁴⁶

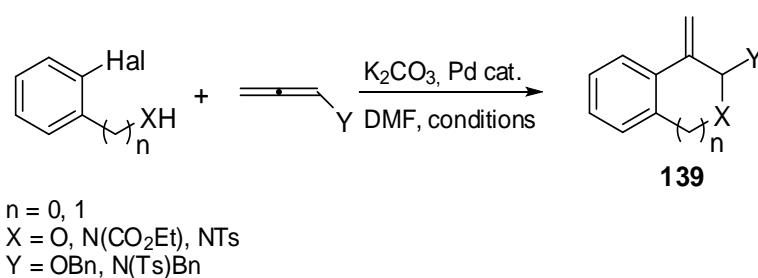

Scheme 51. Palladium-catalyzed annulation process with heteroallenes

A new proposal for the convergent construction of 2,3-disubstituted 3,4-dihydrobenzopyrans which could not be prepared via established palladium-catalyzed annulation was demonstrated by Lu *et al.* (Scheme 52).⁴⁷ The protocol generated two adjacent stereocenters and the insertion of the allenes was highly regioselective. Moreover, the substituent on the allenes was the responsible of the reaction outcome and generated different structures. The authors outlined the synthetic potential of high enantiopurity organometallics **140** with a metal bonded sp^3 -hybridized stereogenic carbon.

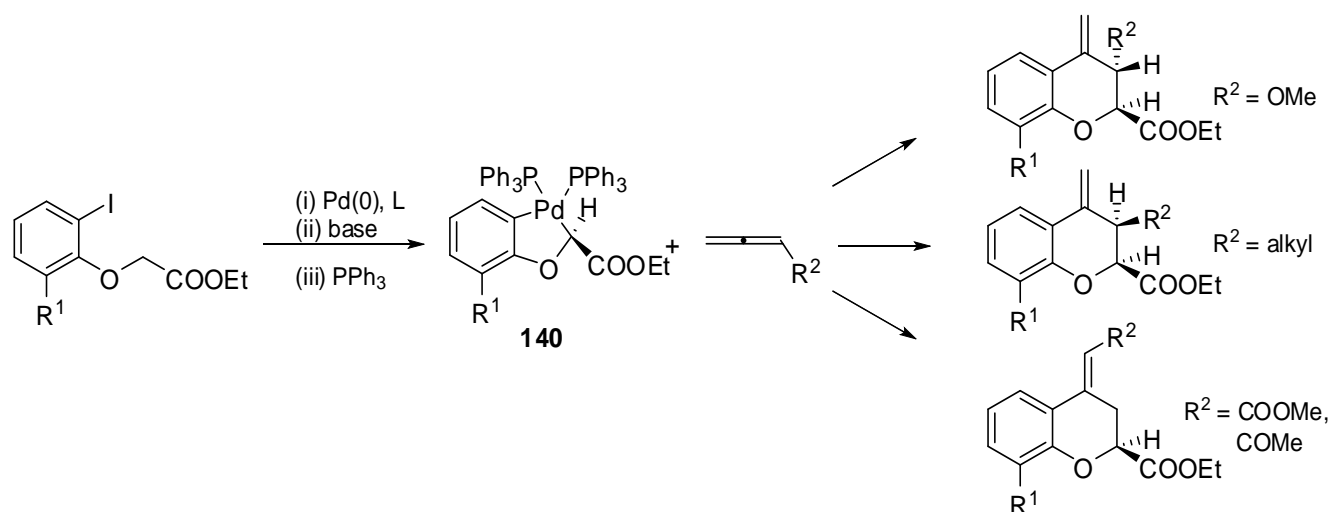

Scheme 52. Convergent construction of 2,3- disubstituted 3,4-dihydrobenzopyrans

Either Pd(OAc)₂ or Pd(OAc)₂/P(2-Tol)₃ were used as a catalyst, and TBAB was added in the case in which *N*-tosyl-2-bromobenzylamine was used as an aryl bromide.

The first Heck type allenylation of aryl halides with allenes has recently been reported by Ma and co-workers. When 3-monosubstituted 1,2-allenyl sulfones were utilized, 1,3-double arylation products **141** were observed, while the corresponding reaction of 3,3-disubstituted 1,2-allenyl sulfones afforded 1-monoarylation products **142** (Scheme 53).

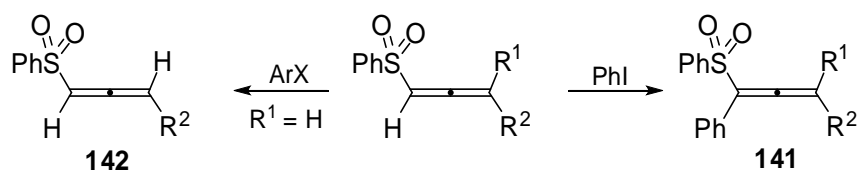

Scheme 53. 1,2-Allenyl sulfones arylation

As shown in Scheme 54, for the first time the formation of substituted allenes **143** from the Heck type reaction of allenes with organic halides via the vinylic Pd intermediate **B** was reported.⁴⁸

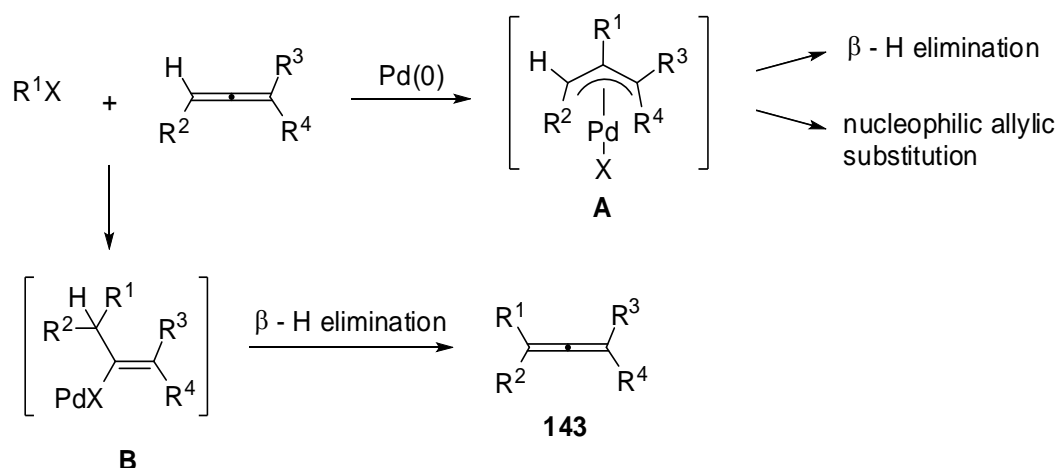

Scheme 54. Proposed mechanism for 1,2-allenyl sulfones arylation

An efficient preparation of cyclopentenes and 4,5-dihydrofurans starting from 2-(2',3'-allenyl)acetylacetates was described by the same research group (Scheme 55). Two different cyclization reactions afforded substituted cyclopentenes **144** with a quaternary stereocenter and 4,5-dihydrofuran derivatives **145a** and **145b** by applying $[AuCl(PPh_3)]$ or $[PdCl_2(PhCN)_2]$ as the catalysts in a *C*-attack-5-*endo* process or by using $[Pd(dba)_2]$ in a *O*-attack-5-*exo* cyclization. The different cyclization modes were probably due to the steric and electronic effects of the substrates and the catalysts. In particular, the regio- and the stereoselectivity for the asymmetric allylic halides was very high, where $[Pd(dba)_2]$ was used.

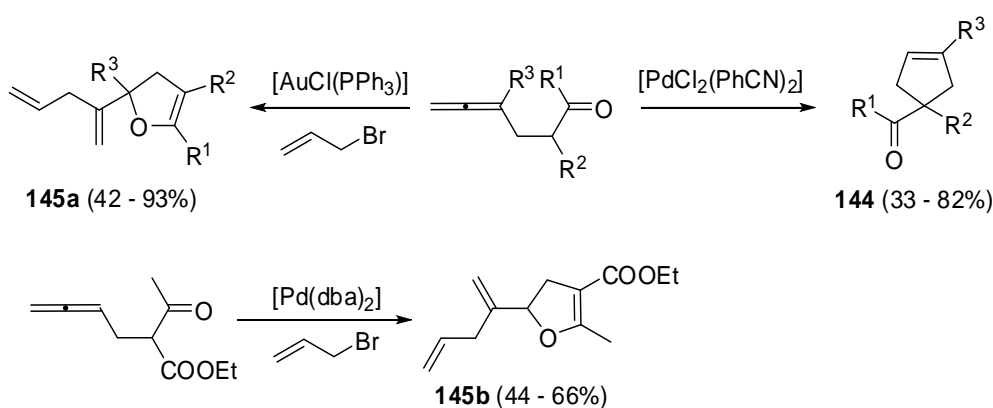

Scheme 55. Preparation of cyclopentenes and 4,5-dihydrofurans from 2-(2',3'-allenyl)acetylacetates

Recently, a new method to prepare α -arylated α,β -unsaturated aldehydes **147** in a stereoselective way has been reported (Scheme 56) by our research group. The starting materials are all commercially available, allene **146** was easily obtained from alkyn-1-ols by isomerization. The key

step was the Heck coupling of the 1,2-dien-1-ols (**146**) with a series of iodo- and bromoarenes. The reaction is regio- and stereoselective, and moreover, experimental conditions turned out to be very mild: in the case of aryl iodides phosphines were not required, while with aryl bromides the cheap and easy available triphenylphosphine was indispensable.⁵⁰

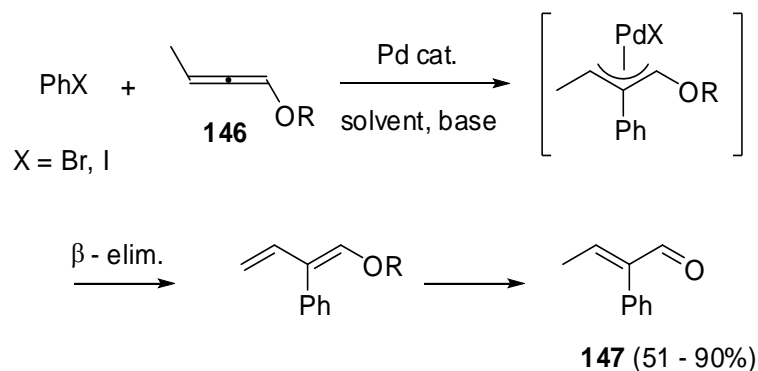

Scheme 56. Synthesis of α -arylated α,β -unsaturated aldehydes

In 2003 we have described the arylation of 1-functionalized-1-alkoxybuta-1,3-dienes (obtained treating α,β -unsaturated acetals with LIC–KOR suberbse and a suitable electrophile) in the presence of a Pd^0 catalyst, which afforded, after hydrolysis, γ -arylated carbonyl derivatives in a regio- and stereoselective manner.⁵¹ Conjugate derivatives that were isomers of the expected dienes were also isolated in the cross-coupling process, starting from acyclic acetals. Since it was known that the Heck reaction is typically carried out in polar solvents, and, moreover, that tetraalkylammonium salts increase the stability of Pd^{II} catalysts, in 2006 we studied the Heck reaction of these substrates in ionic liquids, wondering whether the use of ionic liquids could avoid the isomerization of conjugate dienes.⁵² By reacting iodobenzene and (*E*)-4-ethoxy-octa-1,3-diene **148** (Scheme 57), we optimized the reaction conditions, and subsequently carried out the arylation reactions using tetrabutylammonium bromide as ionic liquid and $\text{Pd}(\text{OAc})_2$ as catalyst, in the presence of NaOAc as a base.

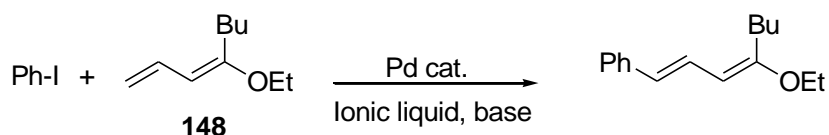

Scheme 57 Heck reaction of iodobenzene and (*E*)-4-ethoxy-octa-1,3-diene in ionic liquids

In Scheme 58 the arylation reactions of various aryl iodides with (*E*)-4-ethoxyocta-1,3-diene **148** and [(*Z*)-1-ethoxybuta-1,3-dienyl]trimethylsilane **149** are shown.

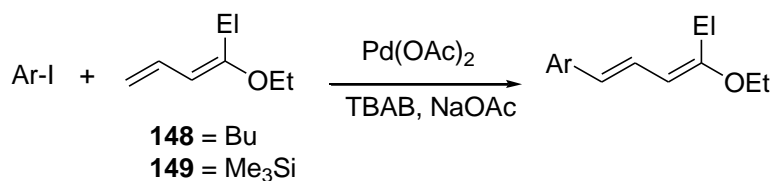

Scheme 58. Arylation reactions of aryl iodides

All the reactions afforded a pure isomer in good yields, both from the regio- and stereochemical point of view.

Recently, Chen and Li reported the intermolecular Heck reaction of activated alkenes with 1-chloro- or 2-chloro-substituted (η -1,3-cyclohexadiene)Fe(CO)₃ complexes **150 a-c**.⁵³ The activation of the vinylic C-Cl bond upon complexation with Fe(CO)₃ should be of important application in organic synthesis, because, in many cases, the high stability of the C(sp²)-Cl bond makes aryl and vinyl chlorides inert (Scheme 59).

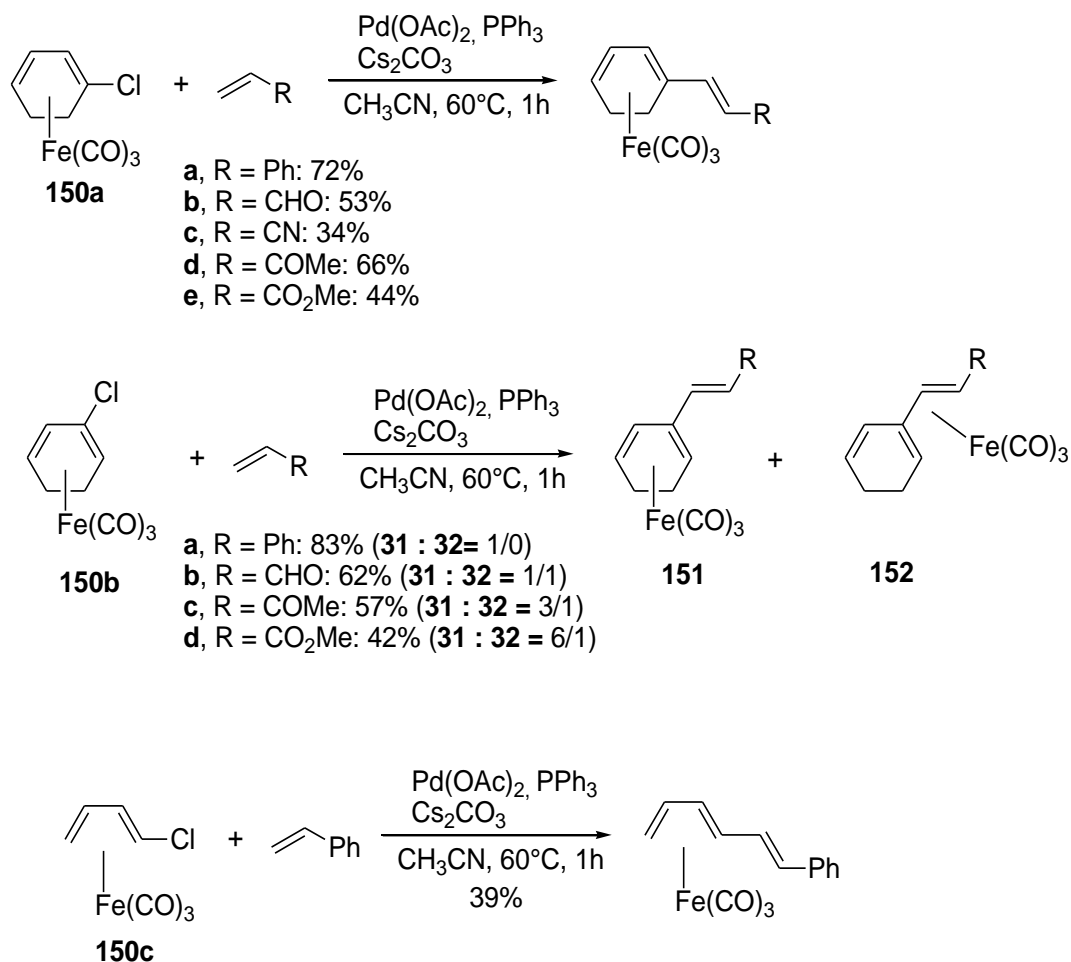

Scheme 59. Intermolecular Heck reaction of activated alkenes with (η -1,3-cyclohexadiene)Fe(CO)₃ complexes

4.2 Sonogashira Reaction

In the same work the authors described also the reactions of the complexes **150 a-c** with terminal alkynes under using PdCl₂(PPh₃)₂/CuI at 45-60 °C (Sonogashira conditions, Scheme 60).

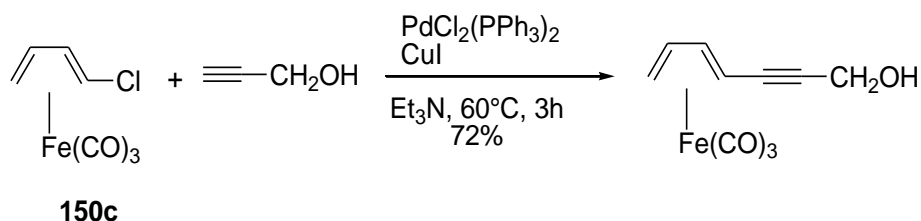
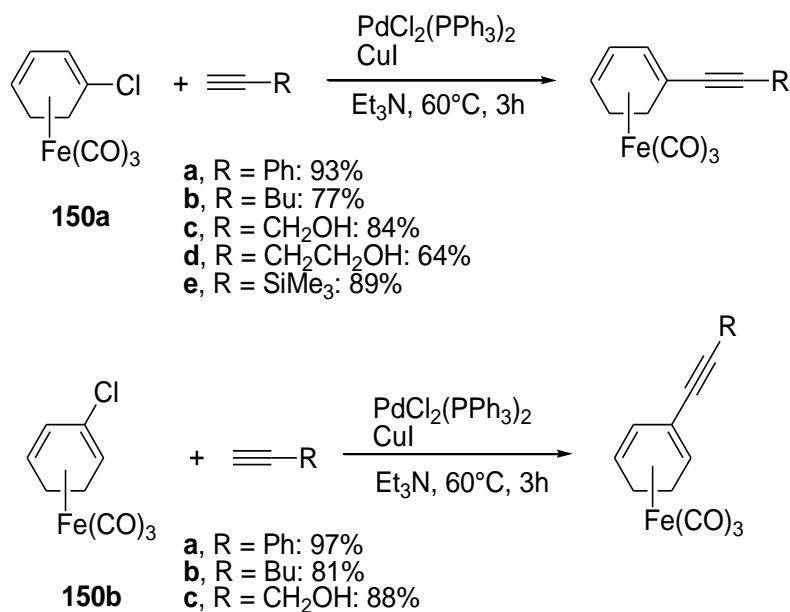

Scheme 60. Sonogashira reaction of terminal alkynes with (η -1,3-cyclohexadiene)Fe(CO)₃ complexes

Wang and Burton⁵⁴ performed the Sonogashira reaction of 1-bromo-1-fluoro-4-phenyl-1,3-butadienes and terminal alkynes in Et₃N. The starting material for this reaction was *trans*-cinnamaldehyde which, upon treatment with CFBr₃ and PH₃P in THF, afforded a mixture of (*E,E*)- and (*Z,E*)-1-bromo-1-fluoro-4-phenyl-1,3-butadienes **153**. After the Sonogashira reaction with the terminal alkynes, dienynes **154** were obtained, which were used in the next cyclization step in the presence of DABCO, affording fluorinated benzene derivatives **155** (Scheme 61), which are of growing importance in the pharmaceutical and agricultural fields.

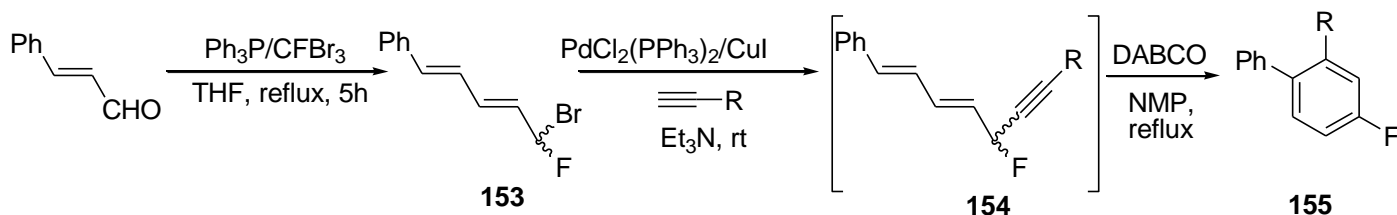

Scheme 61. Synthesis of fluorinated benzene derivatives

A Sonogashira reaction was used by Wu *et al.* in the synthesis of Cepacin A precursors **156** (Figure 3), which is a potent antibacterial substance produced by *Pseudomonas cepacia* SC 11, 783 that was isolated in the 1980s.⁵⁵

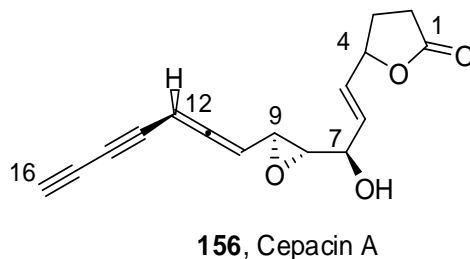
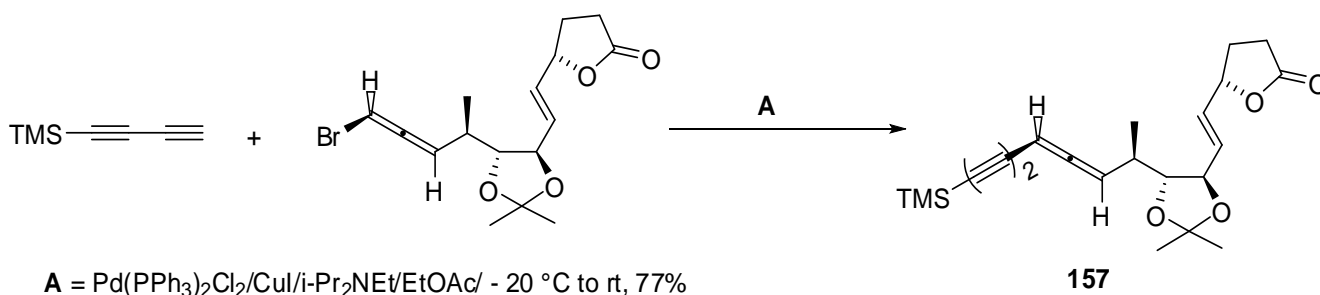

Figure 3. Cepacin A structure

The diyne moiety was introduced by a Sonogashira coupling onto the allenic fragment. Since every attempt tested on the allene containing the epoxydic functionality was negative, the reaction was accomplished on the protected diol allene **157**, a precursor to the desired molecule (Scheme 62).



Scheme 62. Diyne moiety coupling onto the allenic fragment

Denmark and Tymonko synthesized 1,4-disubstituted 1,3-butadienes with a sequential cross-coupling of 1,4-bissilylbutadienes (Hiyama coupling, Scheme 63).⁵⁶

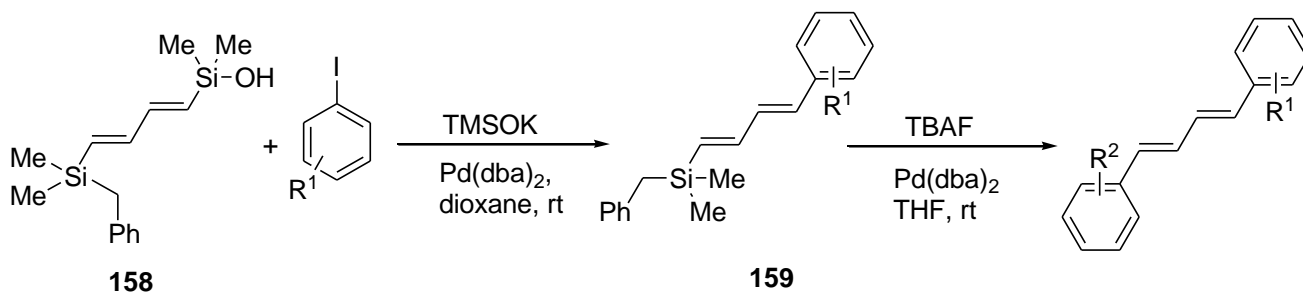

Scheme 63. Hiyama coupling of 1,4-bissilylbutadienes

In this reaction, the selective cross-coupling of the silanol moiety in **158** allowed the fluoride-base activation of the benzyldimethylsilyl unit for the second cross-coupling event.

To avoid the migration of the benzyl group, a process competitive with cross-coupling under fluoride activation, the authors performed the sequential cross-coupling of the bissilane **160**, with a 2-thienyl group instead of the benzyl group (Scheme 64).

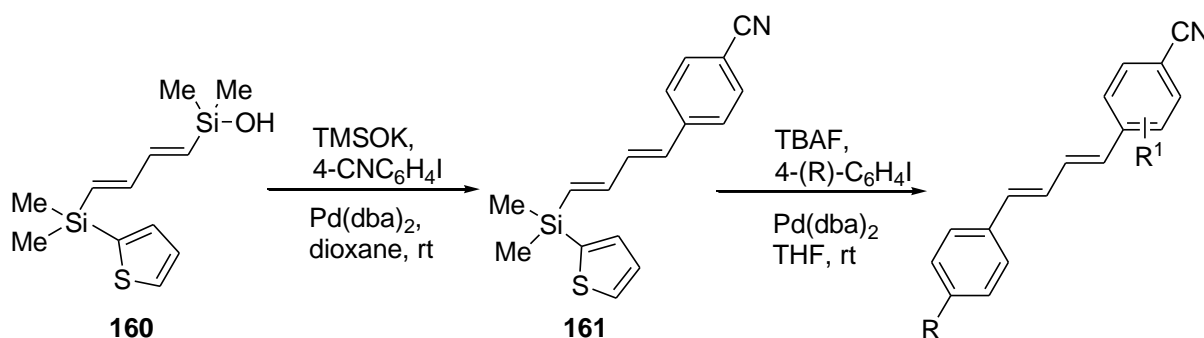

Scheme 64. Sequential cross-coupling

4.3 Suzuki Coupling

A palladium-catalyzed three component procedure that assembles allenes, organic halides and arylboronic acids for the preparation of different organic compounds was proposed under Suzuki coupling conditions by Cheng *et al.* 1,1-Dimethylallene and monosubstituted allenes **162** were used to give the corresponding allylic derivatives **163**. Reactions were accomplished in DMF at 70 °C in the presence of CsF using $\text{Pd}(\text{dba})_2$ as the catalyst. Higher yields were obtained when aryl iodides were used instead of aryl bromides and chlorides (Scheme 65).⁵⁷

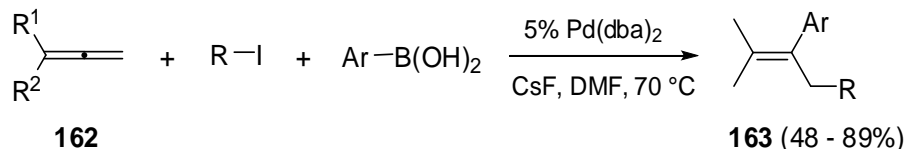

Scheme 65. Synthesis of allylic derivatives

A selective Pd-catalyzed addition of organoboronic acids to allenes in the presence of acetic acid was studied by the Ma research group. It allowed the regio- and stereoselective synthesis of tri- and tetrasubstituted alkenes (**164–166**). The method exhibited a high substituent-loading capability and strong tolerance to various substituents. 2- (2',3'-Dienylmalonates) and allenates were reacted

with different substituted organoboronic acids in THF in the presence of Pd(PPh₃)₄ at reflux.⁵⁸ A hydropalladation-Suzuki coupling mechanism was proposed (Scheme 66).

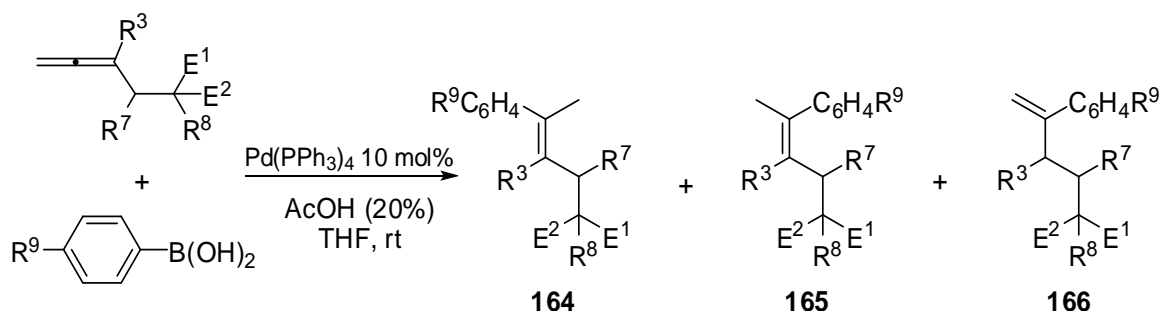

Scheme 66. Palladium-catalyzed addition of organoboronic acids to allenes in acidic conditions

As a first example of carbocyclization reaction of allenes, a cascade reaction which utilizes a Pd(0) catalyzed 1,2,7-triene **167** cyclization and a Suzuki coupling reaction to give cyclic products was proposed by Zhang and co-workers.⁵⁹ Reactions were carried out in toluene, at 50 °C using Pd(dba)₂ in CHCl₃ or Pd(PPh₃)₄ as Pd(0) sources, and K₃PO₄ as a base (Scheme 67).

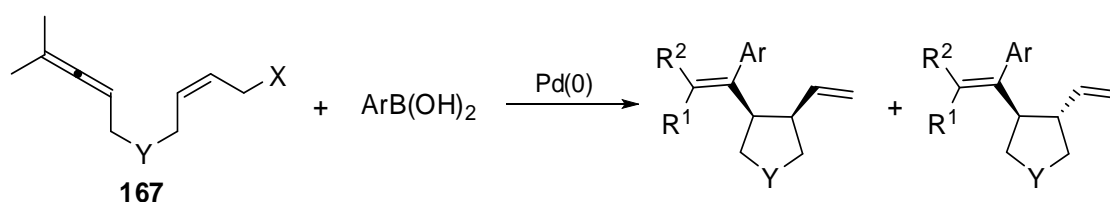

Scheme 67. Cascade Pd(0) catalyzed 1,2,7-triene (**167**) cyclization-Suzuki coupling

A catalytic four-component reaction which involves allenyl boronate pinacol ester was developed by Yoshida *et al.* The allene was treated with an amine, 4-iodotoluene and 3-iodothiophene in the presence of Pd(dba)₂, P(2-furyl)₃ and *i*-Pr₂NEt₂ in toluene at 80 °C. A set of functionalized allylic amines **168** was obtained in a regioselective, stereoselective and diversity-oriented manner (Scheme 68).⁶⁰

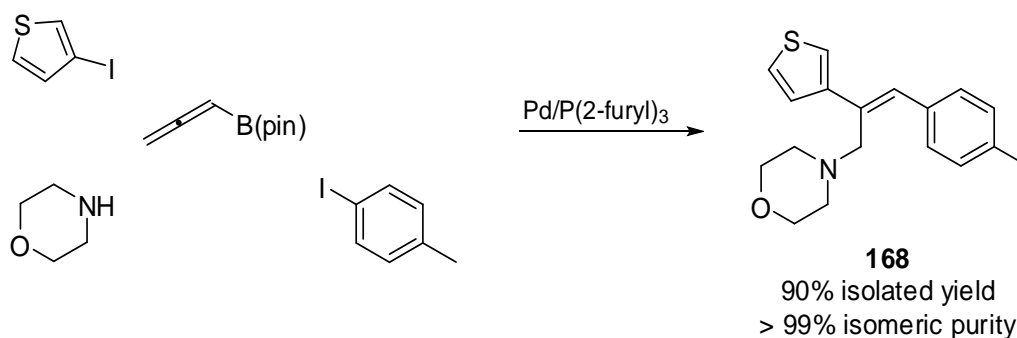

Scheme 68. Synthesis of functionalized allylic amines

A Pd-catalyzed diboration of prochiral allenes to obtain a reactive chiral allylboron intermediate which has been used for the allylation of carbonyls, for Suzuki cross coupling and for the allylation of allenes and imines was proposed by Morken *et al.* The reactions represented in Scheme 69, were all one pot preparation of enantioselective allylic alcohol **169**, aromatic and alkenyl diols **170** and β -amidoketones **171**.⁶¹

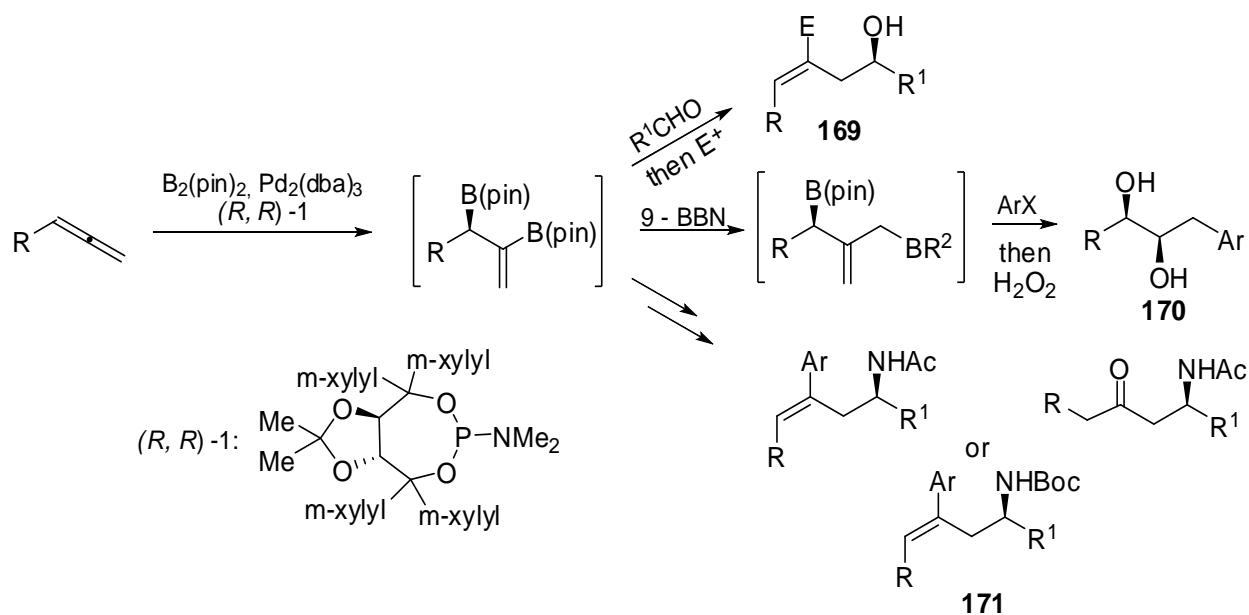

Scheme 69. Palladium-catalyzed diboration of prochiral allenes

In our recent studies, we have developed a new synthesis of butadienylboronic esters,⁶² starting from α,β -unsaturated acetals, in the presence of LIC-KOR superbase (Scheme 70).

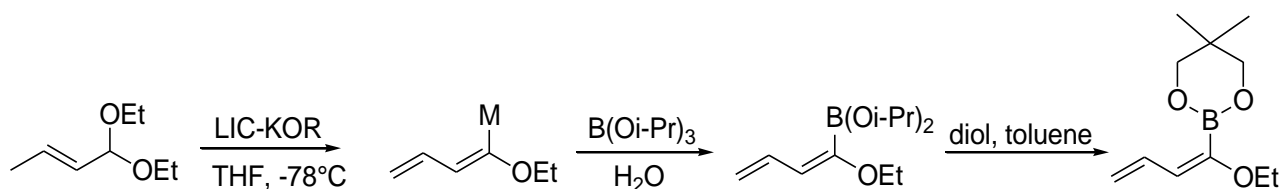

Scheme 70. Synthesis of butadienylboronic esters

The ethoxydienylboronates thus formed can react with α -tetralones-derived triflates **172**, according to Suzuki-Miyaura conditions, to afford conjugated ethoxytrienes, which undergo cyclization in the presence of Amberlyst-15[®], giving tricyclic derivatives (Scheme 71).⁶³

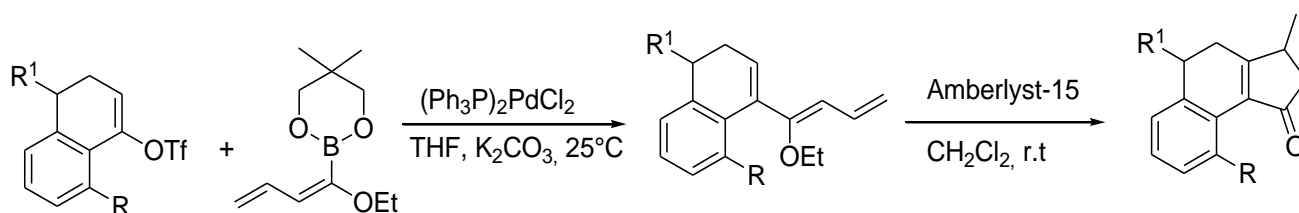

- 172a:** R = R¹ = H
172b: R = H; R¹ = Me
172c: R = OMe; R¹ = H

Scheme 71. Synthesis of tricyclic derivatives

In the field of the natural substances, Shimizu and co-workers⁶⁴ reported the synthesis of a variety of [3]- to [6]dendralenes **175**, lignans **176**, and 2,3-diaryl-1,3-butadienes **177**, obtained by Pd-catalyzed coupling of 2,3-bis(pinacolato)boryl-1,3-butadiene **174** with organic halides. Formation of **174** derived from the reaction of 1,1-bis(pinacolato)diboron **173** with 1-bromo-1-lithioethene in excess (Scheme 72).

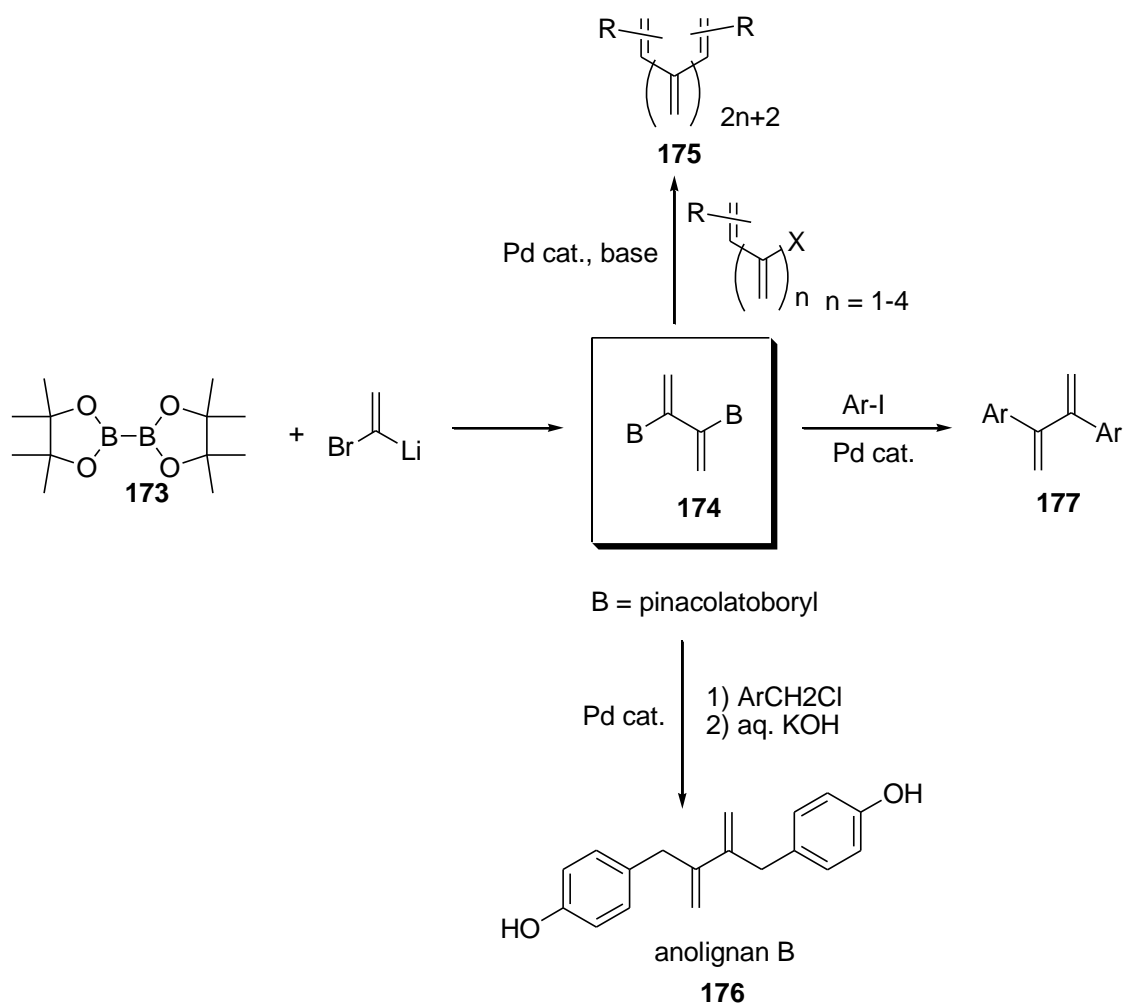

Scheme 72. Palladium-catalyzed coupling of 2,3-bis(pinacolato)boryl-1,3-butadiene with organic halides

In another work,⁶⁵ the authors reported the stereoselective Pd-catalyzed cross-coupling reaction of 2,4-aryl-1,1-bis(pinacolatoboryl)-1,3-butadienes **178** with aryl iodides at room temperature, affording the corresponding boronates **179** as a single diastereomer. Further coupling reaction of the boronates thus obtained with alkenyl iodides established a stereocontrolled approach to a variety of 1,3,4,6-tetraarylated 1,3,5-hexatrienes **180** (Scheme 73).

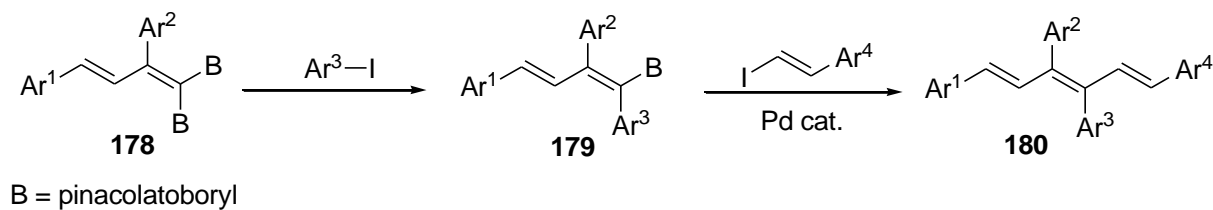

Scheme 73. Synthesis of 1,3,4,6-tetraarylated 1,3,5-hexatrienes

Diboryl alkenes **178** were prepared by 1,1-diborylation of 2,4-aryl-1,1,-dibromo-1,3-butadienes with bis(pinacolato)diboron, as reported by the same authors.^{66,67} The stereoselectivity of the process can be explained by assuming that the reaction takes place with the less hindered boryl group.

Symmetrical (1*E*,3*E*)-1,4-diarylbuta-1,3-dienes **182** were synthesized by Babudri and co-workers,⁶⁸ with a stereoselective palladium catalyzed Suzuki–Miyaura cross-coupling reaction of (1*E*,3*E*)-1,4-diiodobuta-1,3-diene **181** with arylboronic reagents (Scheme 74).

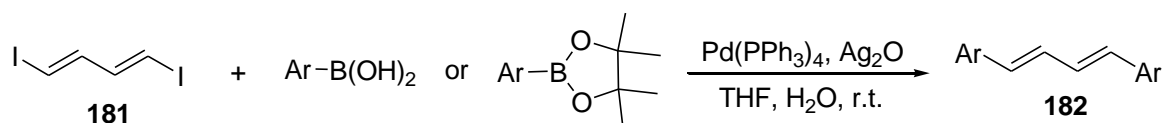

Scheme 74. Synthesis of symmetrical (1*E*,3*E*)-1,4-diarylbuta-1,3-dienes

The mild experimental conditions allowed the use of variously substituted arylboronic acid reagents, affording functionalized 1,4-diarylbuta-1,3-dienes in good yields.

Morita and co-workers⁶⁹ reported the synthesis of multisubstituted 1,3-dienes using the Suzuki–Miyaura coupling reaction of 2-boryl-3-organo-1,4-disilyl-1,3-butadienes **183**.

To obtain dienes **183**, the authors performed a ruthenium-catalyzed double addition of trimethylsilyldiazomethane to alkynylboronates. As showed in

Scheme 75, alkenylboronates **183** coupled with iodobenzene to give 1,4-disilyl-1,3-butadienes **184**, which underwent selective iodolysis by treatment with *N*-iodosuccinimide (NIS) at 0 °C. Alkenyl iodide **185** cross-coupled with *p*-tolylboronic acid according to a further Suzuki–Miyaura coupling reaction, to afford monosilydene **186**. Iodolysis of **186** with NIS furnished alkenyl iodide **187**, which was converted to 1,3-butadiene **188** possessing four different substituents. Alternatively, diiodide **189** (obtained by iodolysis of both the Si-C bonds in **184**) reacted with *p*-tolylboronic acid leading to tetrasubstituted 1,3-butadienes **190** with three different organic groups.

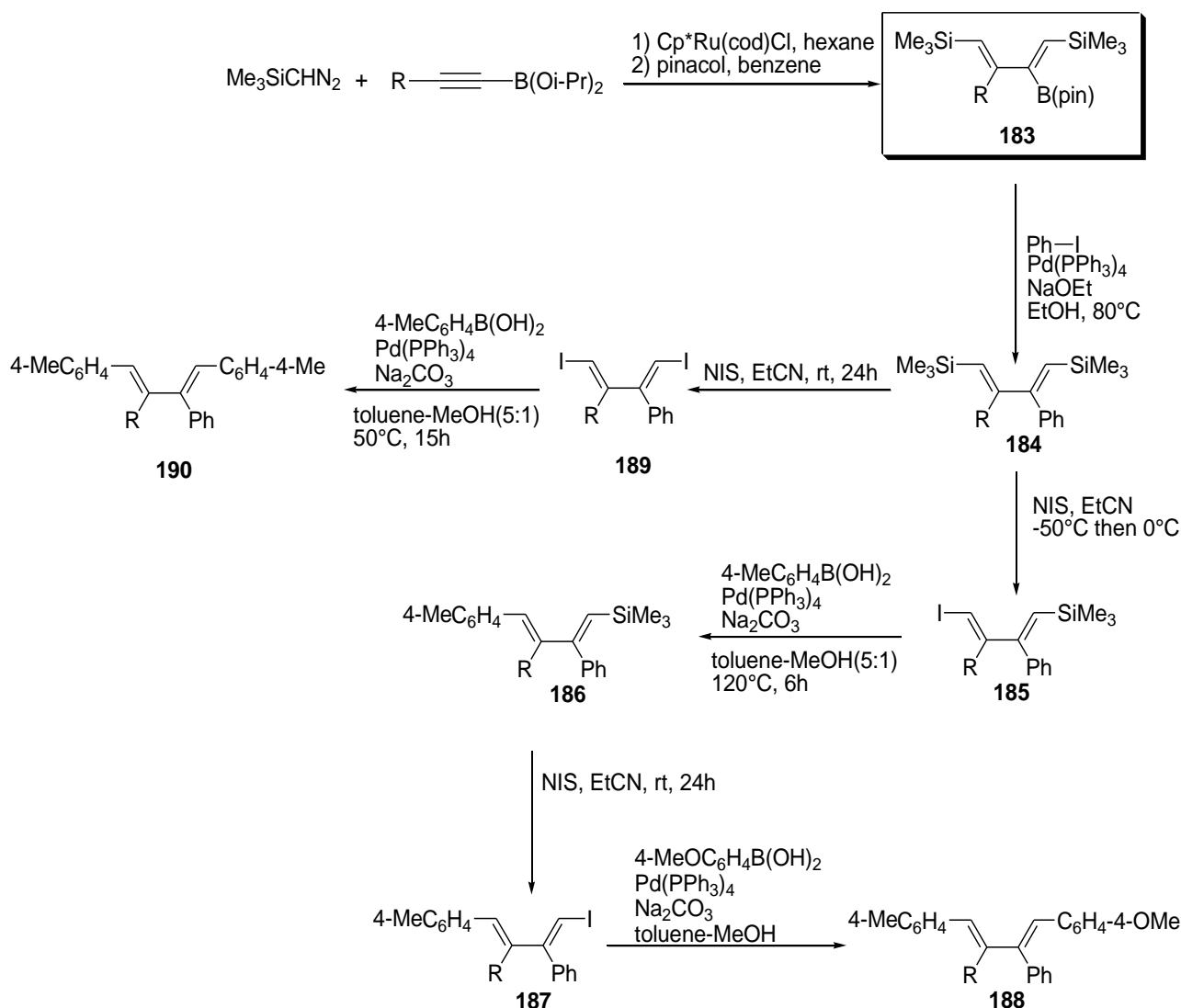

Scheme 75. Suzuki–Miyaura coupling reaction of 2-boryl-3-organo-1,4-disilyl-1,3-butadienes

In 2007 Lopez, Montenegro and Saá described the stereospecific synthesis of 11-*cis* retinoids.⁷⁰ The key step of this synthetic route was the Suzuki–Miyaura reaction of *trans*-trienyl electrophiles and (1*Z*,3*E*)-penta-1,3-dienyl boronates **191**, so far unexplored. Pinacol *cis*-vinylboronates **191** were synthesized with four different methods (Scheme 76). Method A described the rhodium-catalyzed *trans*-hydrometalation of terminal acetylenes, following Miyaura's conditions.⁷¹ Method B is based on the hydrozirconation of 1-alkynylmetals with zirconocene hydrochloride [Cp₂Zr(H)Cl]; 1-alkyldioxaborolane **192** was obtained in quantitative yield by reaction of the lithioalkyne derivative

of **193** with 2- isopropoxy-4,4,5,5-tetramethyl-1,3,2-dioxaborolane, followed by addition of ethereal hydrogen chloride.

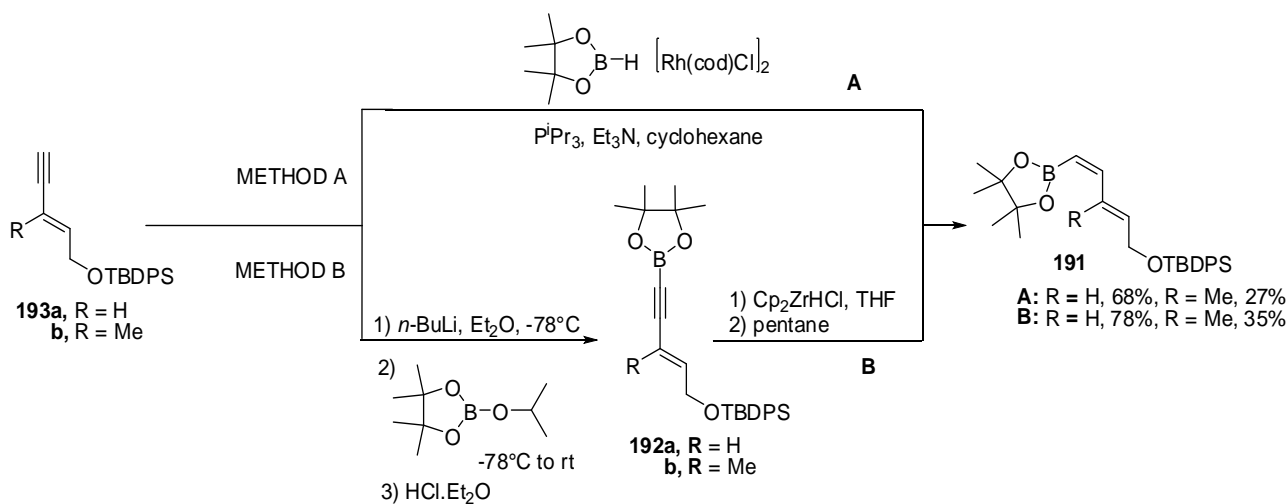

Scheme 76. Synthesis of pinacol *cis*-vinylboronates

An alternative method starting from precursor iodide **194**, afforded the boronate **191b** in satisfactory yields (Method C), while Method D described the palladium-catalyzed cross-coupling with nucleophilic metallic species (Scheme 77).

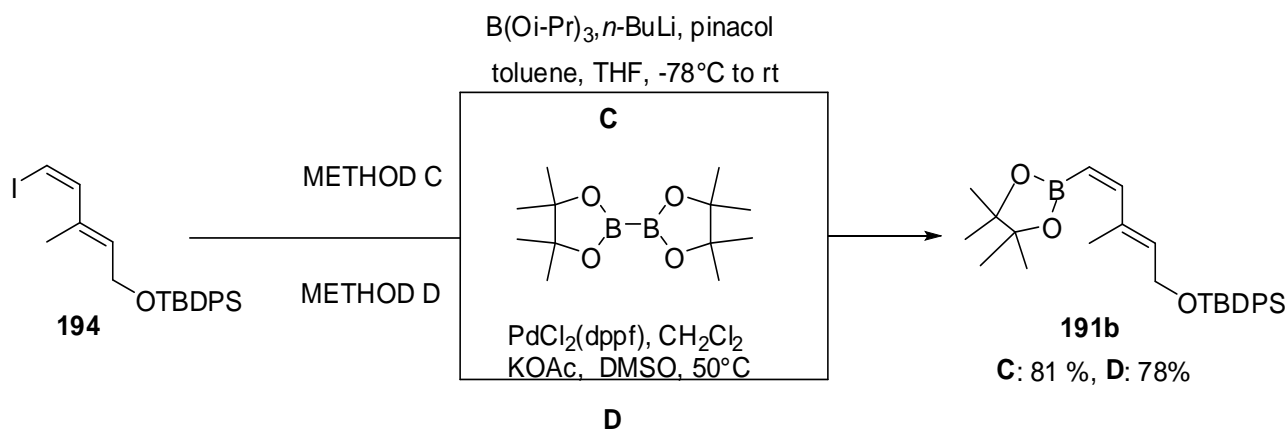

Scheme 77. Alternative method for the synthesis of dienyl boronates

The dienyl boronates **191a** and **191b** were then coupled with iodides **195**, according to the thallium accelerated version of the Suzuki coupling [$\text{Pd}(\text{PPh}_3)_4$, TlOH (aq), THF, rt],⁷² giving 11-*cis*-retinyl ethers **196** (Scheme 78).

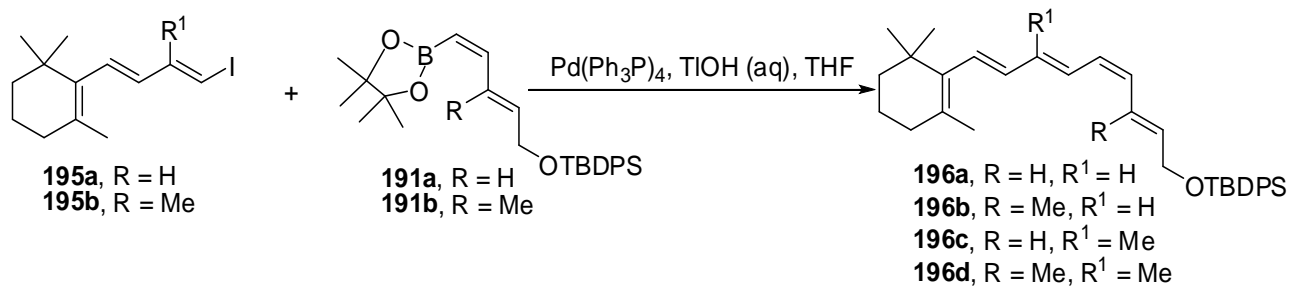

Scheme 78. Thallium accelerated version of the Suzuki coupling

4.4 Stille Coupling

The authors reported the synthesis of the same products performed with the Stille coupling of *trans*-trienyl electrophiles and (1*Z*,3*E*)-penta-1,3-dienyl stannanes **197a** and **197b**. These compounds were prepared using methods B (hydrozirconation of 1-alkynylmetals) and D (Pd-catalyzed cross-coupling with nucleophilic metallic species), because methods A and C furnished the desired stannanes only in traces amounts (Scheme 79).

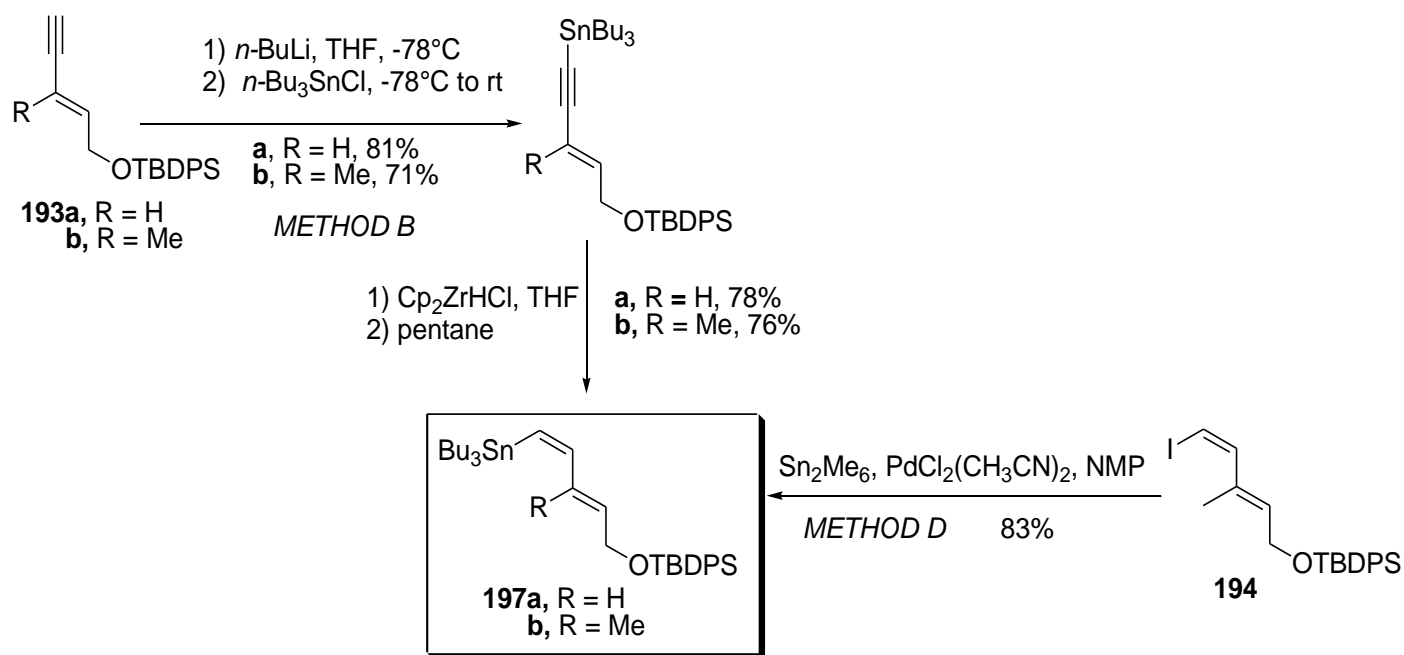

Scheme 79. Stille coupling of *trans*-trienyl electrophiles

The Stille cross-coupling reactions of iodides **195a** with **197a** and **197b** and of **195b** with **197a** were carried out under ligand-free conditions (Scheme 80), while for the coupling of **195b** with **197b**, the authors reported the Baldwin's variant of the Stille reaction, employing the more reactive trimethylvinyl stannane **198** (Scheme 81).

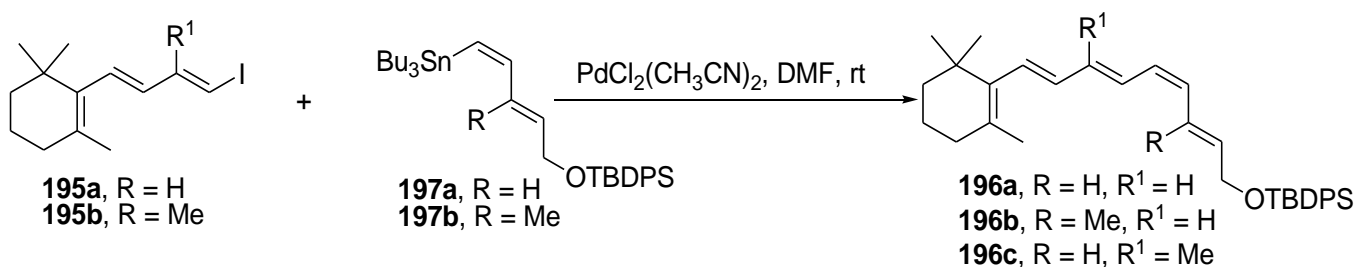

Scheme 80. Stille cross-coupling reactions of iodides

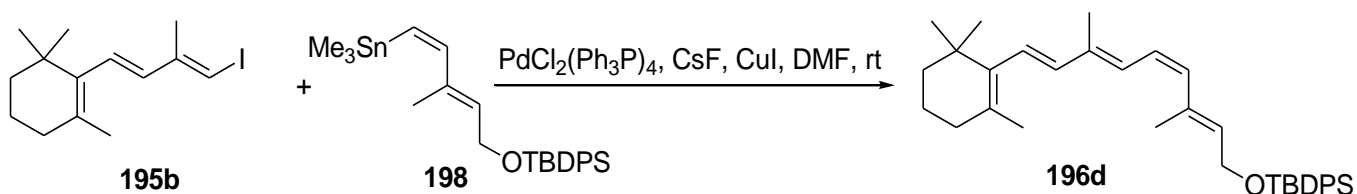

Scheme 81. Baldwin's variant of the Stille reaction

A lot of work about the applications of allenes in Stille cross coupling has been done by Abarbri and co-workers. They exploited the Pd-catalyzed regio- and stereoselective annulation of allenylstannanes **199** by β -iodo vinylic acids and amides **200** to obtain α -pyrones and α -pyridones **201** in high yields. The reaction probably proceeded in a one pot Stille coupling–annulation process (Scheme 82).⁷³

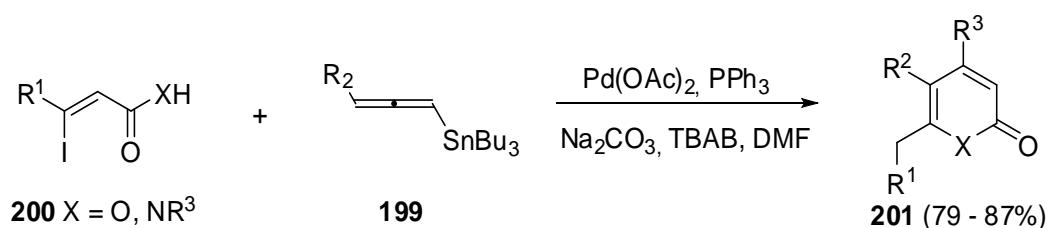

Scheme 82. Regio- and stereoselective annulation of allenylstannanes

The same reaction scheme was used to synthesize 2-pyridinones, 2,3-disubstituted (2*H*)-9-isoquinolin-1-ones and isocumarins.⁷⁴

Various monosubstituted arylallenes were prepared by a chemoselective coupling of allenylstannanes with iodoarenes by Cheng and co-workers. The reaction was promoted by Pd(PPh₃)₄ and LiCl and was also applied to alkenyl iodides.⁷⁵

Tributylallenylstannane was used by Guillaumet et al to functionalize 2,4-dichloropyrido-[2,3-*d*]pyrimidine and 5-iodouracil-4,5-didehydro-5,6-dideoxy-L-ascorbic acid under Stille reaction conditions in good yields. The compounds prepared in this manner have potential anticancer, anti-viral and anti-inflammatory properties.⁷⁶ As shown in Scheme 83, the Stille coupling of *N*-acyl-2-iodoanilines (**202**) with 1-(tributylstannyl)-1-substituted allenes **203** was the main step in the formation of the 2-methyl-3-substituted indoles **204**. The same structures were also achieved by a one pot operation, which consists of the Stille coupling reaction with 1-(tributylstannyl)-1,3-disubstituted allenes, followed by TBAF treatment. The methodology, studied by the research group of Takahashi, was applied to the synthesis of indomethacin, an anti-inflammatory, non steroid agent with an indole nucleus.⁷⁷

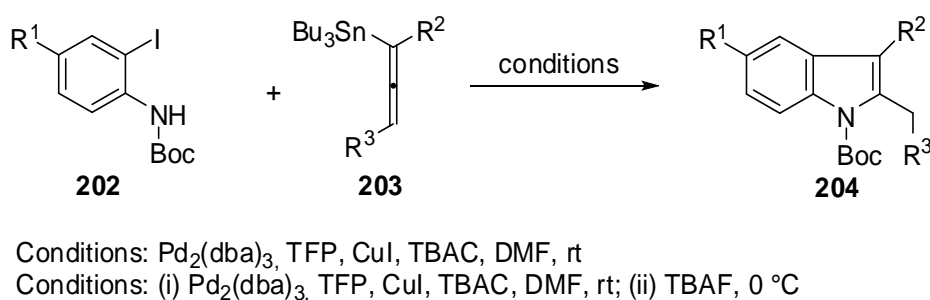

Scheme 83. Synthesis of the 2-methyl-3-substituted indoles

(+)- β -Cuparenone (**206**) is a sesquiterpene from the essential oil of *Mayur pankhi* and the liverwort *Mannia fragrans*. It was prepared by Hodgson and co-workers starting from commercially available 4-iodotoluene, Bu₃SnSiMe₃ and 3-methyl-1,2-butadiene. They underwent a Pd(dba)₂-catalyzed three component coupling reaction to give the allylsilane **206** (Scheme 84) in a 50% yield as a precursor to the desired terpene.⁷⁸

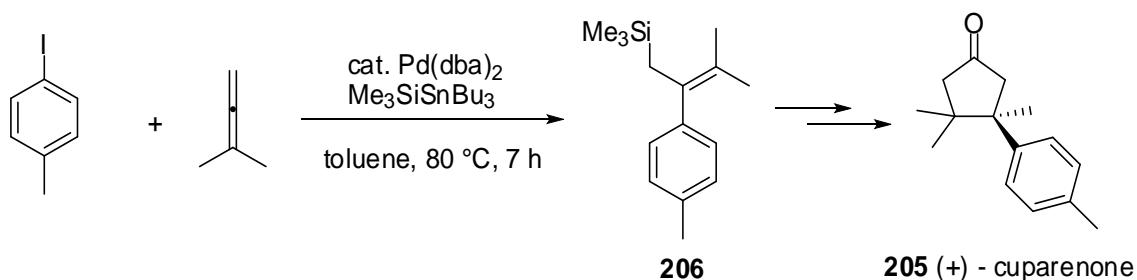

Scheme 84. Catalytic three component coupling reaction

4.5 Miscellaneous

Trostyanskaya and co-workers⁷⁹ reported the palladium-catalyzed cross-coupling of 1,4-diiodobutadienes with benzenethiols, affording 1,4-Bis(R-sulfanyl)buta-1,3-dienes, which are precursors of a variety of biologically active natural compounds, such as thiarubrines.

Both Pd(PPh₃)₄ and bis(triphenylphosphine)palladium(II) dichloride as catalysts, as well as bidentate chelating phosphine ligands, furnished, in the presence of potassium *tert*-butoxide as a base, 1,4-bis(phenylsulfanyl)buta-1,3-diene in high yield (Scheme 85).

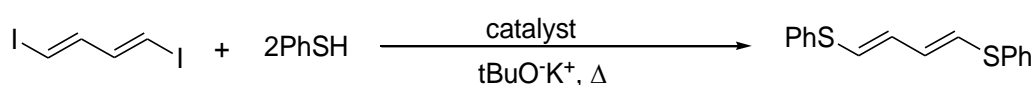

Scheme 85. Palladium-catalyzed cross-coupling of 1,4-diiodobutadienes with benzenethiols

Ogasawara and colleagues studied the synthesis and the application of (1,2,3- η^3 -butadien-3-yl)palladium complexes as a catalyst precursor in allene synthesis reaction (Figure 4).⁸⁰

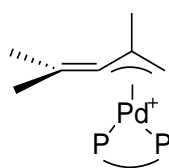
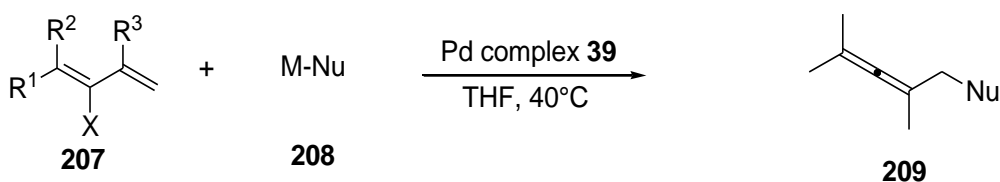

Figure 4 (1,2,3- η^3 -Butadien-3-yl)palladium complexes

For this scope, this palladium complex was applied to reactions of 2-bromo-1,3-dienes (or a 1,3-dien-2-yl triflate) **207** with stabilized nucleophiles **208**, giving di-,tri- and tetrasubstituted allenes **209** (Scheme 86).



- 207a:** R¹ = Ph, R² = R³ = H, X = Br
207b: R¹ = ⁿC₈H₁₇, R² = R³ = H, X = Br
207c: R¹ = ^tBu, R² = R³ = H, X = Br
207d: R¹ = R² = R³ = Me, X = Br
(Z)-207e: R¹ = Ph, R² = Me, R³ = H, X = Br
(E)-207e: R¹ = Me, R² = Ph, R³ = H, X = Br
207f: R¹ = Me, R² = Ph, R³ = H, X = OTf

- 208a:** Na[CMe(COOMe)₂]
208b: K[C(NHAc)(COOEt)₂]
208c: KN(Boc)₂

Scheme 86. Synthesis of di-,tri- and tetrasubstituted allenes

Barluenga and co-workers⁸¹ described the synthesis of 1-amino-1,3-butadienes, prepared by Pd-catalyzed cross-coupling of secondary amines with 1-halodienes. The reaction proceeds in very high yields with 1-bromo-1,3-butadienes and also with 1-chloro-1,3-butadienes. Aromatic, cyclic and acyclic aliphatic amines can be incorporated in this way, employing Pd₂(dba)₃ and XPhos as supporting ligand (Scheme 87).

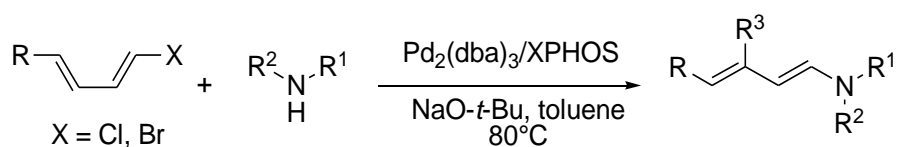

Scheme 87. Synthesis of 1-amino-1,3-butadienes

Shi, Ramgren and Blum⁸² developed a new palladium-catalyzed carboauration of alkynes, affording α -ester vinyl-gold intermediate **210** with complete regioselectivity and diastereoselectivity for the product of syn addition. As described in Scheme 88, the crude vinyl-gold species **210** thus obtained were employed without isolation in the next intermolecular Pd-catalyzed cross-coupling reactions with allyl bromide, methyl iodide or 4-iodotoluene, providing di- and trisubstituted olefins with high diastereoselectivity and absolute regioselectivity. The residual Pd catalyst from the carboauration reaction remained viable for the subsequent cross-coupling step, establishing a one-pot tandem carboauration/functionalization protocol.

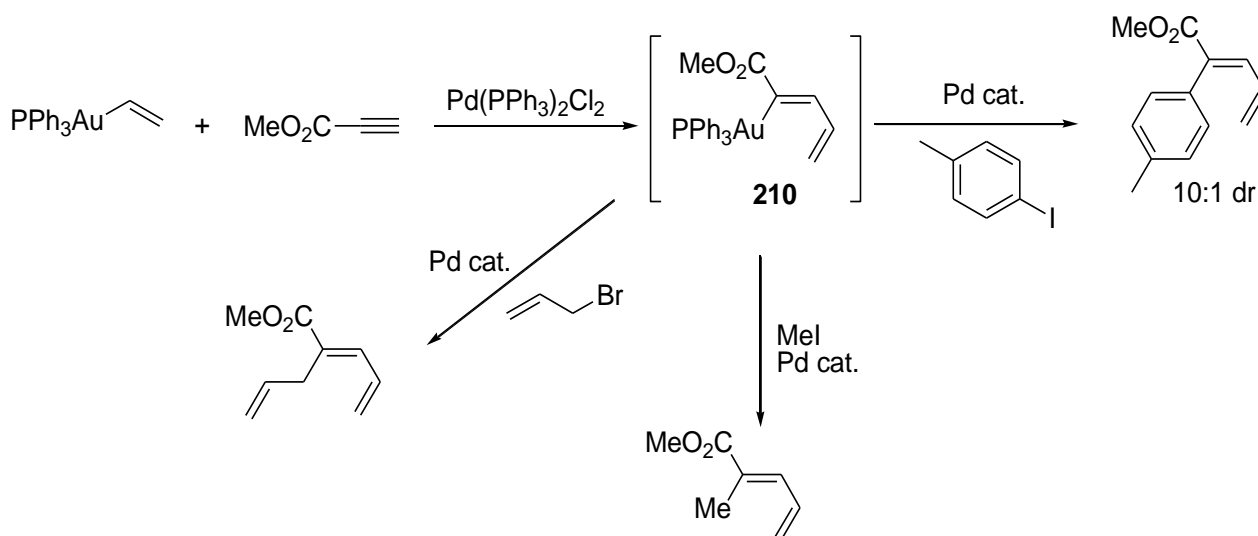

Scheme 88. One-pot tandem carboauration-functionalization of alkynes

Leitner and co-workers⁸³ described an intermolecular palladium-catalyzed addition of the α -C-H bond of mono- and dicarbonyl compounds to conjugated dienes. In the mechanism proposed, the authors reported the attack of the enolate on the allyl intermediate (generated without the need for a leaving group or external base), furnishing the final addition product (Scheme 89).

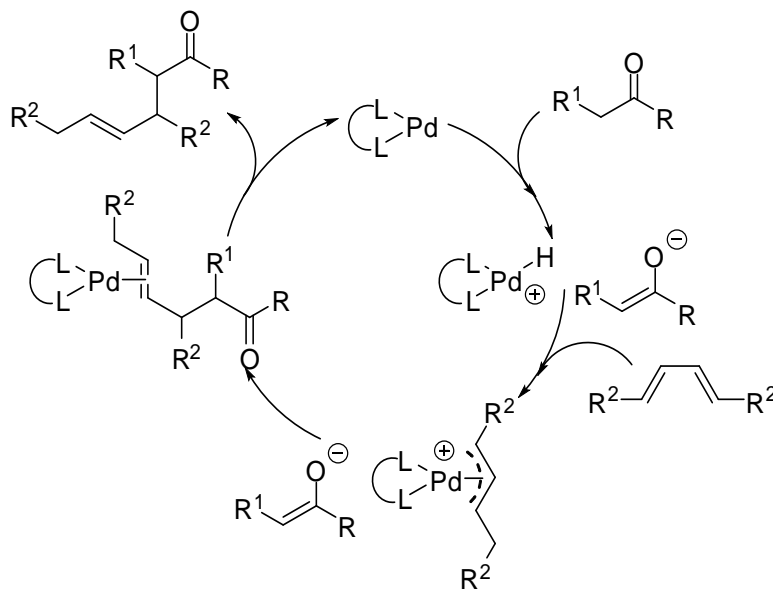

Scheme 89. Mechanism of the palladium-catalyzed addition of the α -C-H to conjugated dienes

As a result, the combination of CpPd(allyl) and 1,3-bis(dicyclohexylphosphino)propane (DCyPP) catalyzed the 1:1 addition of the C-H bonds of ketones, lactones, esters and nitriles to both cyclic and acyclic dienes. The authors performed also an enantioselective version of this addition reaction, which occurred between 2,4-pentandione and 1,3-cyclohexadiene with 81% ee, in the presence of a catalyst generated from CpPd(allyl) and Josiphos ligand with one di-*tert*-butylphosphino group and one diphenylphosphino group (Scheme 90).

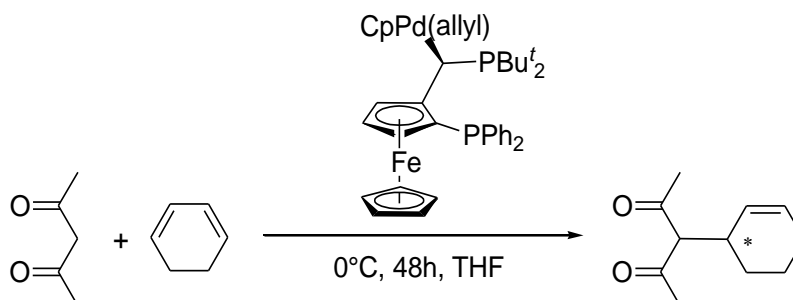

Scheme 90. Enantioselective addition reaction

Gulías and co-workers⁸⁴ explored a new type of Pd-catalyzed [4+3] intramolecular cycloaddition that furnished 5,7-fused bicyclic systems from dienylidenecyclopropanes (Scheme 91).

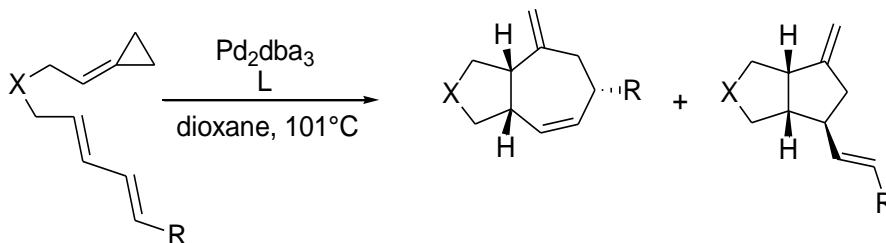

Scheme 91. Pd-catalyzed [4 + 3] intramolecular cycloaddition

The selectivity of the reaction (seven- versus five-membered adduct) was highly influenced by the nature of the ligand. Noteworthy, the cyclization process generated three stereocentres in a completely diastereoselective manner.

Some cycloaddition precursors were assembled through a Pd-catalyzed coupling combined with the cycloaddition in a one-pot process, as represented in Scheme 92, employing the chiral ligand **211**.

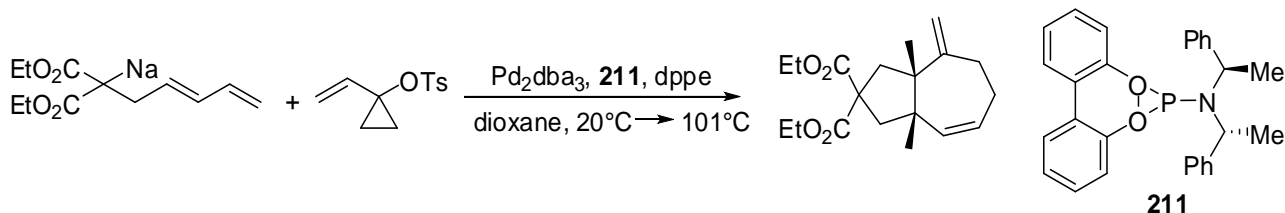

Scheme 92. One-pot Pd-catalyzed coupling-cycloaddition

A new preparation for the silaboration of allenes **212** catalyzed by palladium complexes and initiated by organic iodides by a three-component assembling pathway has been demonstrated by Cheng *et al.*⁸⁵ The regio- and stereoselectivity showed is opposite in comparison to those previously reported. Moreover the achievement of chiral homoallylic **213** alcohols from the reaction of borosilane, allenes and aldehydes is described (Scheme 93).

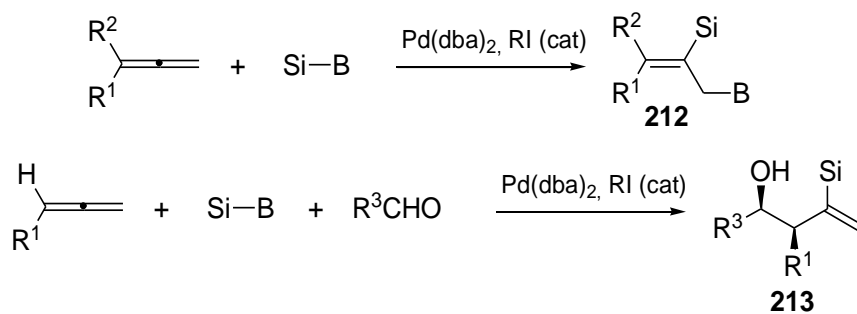

Scheme 93. Silaboration of allenes

Recently a Pd- catalyzed silaboration of terminal allenes for the synthesis of the allylsilanes bearing boryl groups at their β -positions was reported by Suginome and co-workers. The formation of optically active β -borylallylsilanes **214** was achieved under double asymmetric induction conditions using an optically active ligand and a chiral auxiliary on the boron atom of the silylborane (Scheme 94).⁸⁶

Different chiral phosphines were used, in particular modified diarylphosphino group on the 1,1'-binaphthyl skeleton gave the best results in enantioselectivity.

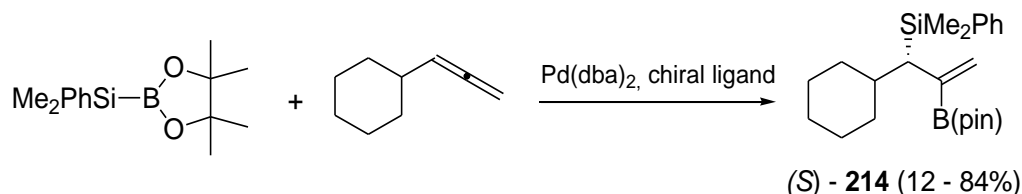

Scheme 94. Synthesis of optically active β - borylallylsilanes

A diastereoselective germastannylation of bis(allenes) with germylstannanes, catalyzed by palladium complexes to obtain *cis* and *trans* five membered cyclic system was investigated by Yu et al. The author observed that the relative products stereochemistry strongly depended on the substituents in the reagent containing Ge-Sn σ bonds. The use of $\text{Me}_3\text{GeSnBu}_3$ produced *trans*-cyclized products **215**, whereas *cis*-cyclic compounds **216** were obtained in the presence of $\text{Bu}_3\text{GeSnBu}_3$ (Scheme 95).⁸⁷

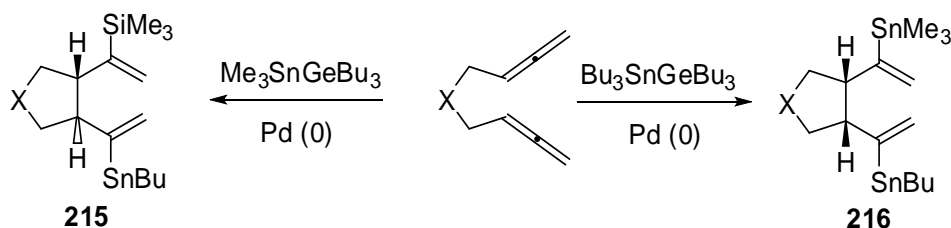

Scheme 95. Germastannylation of bis(allenes) with germylstannanes

Functionalized allyl selenides **217** with the acyl moiety at the inner carbon and the SePh group at the terminal carbon were obtained by Kambe research group via a palladium catalyzed regio- and stereoselective selenoacylation of allenes with selenols esters (Scheme 96).⁸⁸

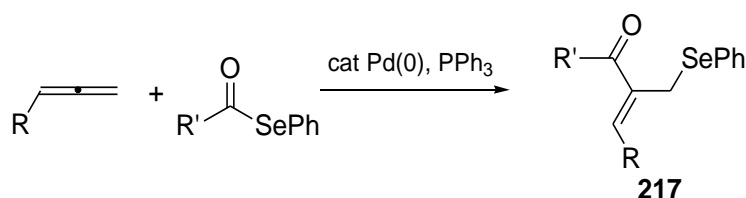

Scheme 96. Synthesis of functionalized allyl selenides

The reaction of allenes with active methynes and methylenes in the presence of $\text{Pd}(\text{PPh}_3)_4/\text{PhCOOH}$ as a combined catalyst to give monoallylated products with *E*-diastereoselectivity in good yields was studied by Yamamoto and co-workers.⁸⁹ The products were obtained with an unexpected stereoselectivity in comparison to previous catalysts which produces a mixture of *E* and *Z* stereoisomers (Scheme 97).

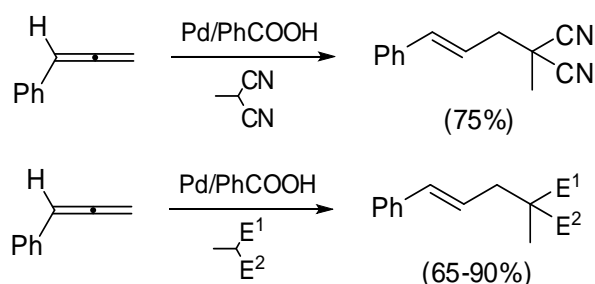

Scheme 97. Reaction of allenes with active methynes and methylenes in the presence of $\text{Pd}(\text{PPh}_3)_4/\text{PhCOOH}$

1-Alcoxyallenes were used by Trost and co-workers as the proelectrophiles in a palladium catalyzed asymmetric allylic alkylation which proceeded with 1,3-dicarbonyl compounds as the pronucleophiles with excellent regioselectivity and enantiomeric excess as shown in Scheme 98.

The pH medium was demonstrated to be crucial for the reactivity/selectivity of the reactions. Based upon experimental evidences, a mechanism involving a hydropalladation step instead of the carbopalladation alternative was proposed by the authors.⁹⁰

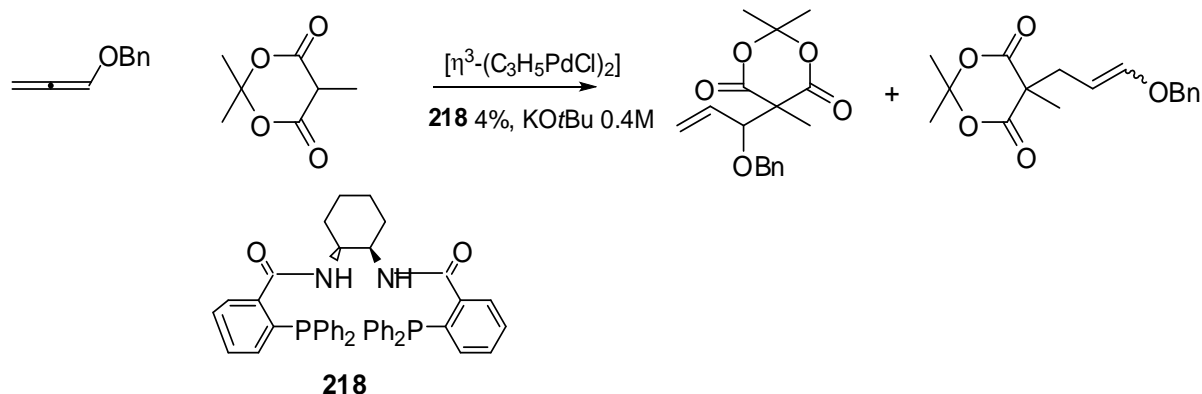

Scheme 98. Palladium catalyzed asymmetric allylic alkylation

A mild, palladium (II) catalyzed heterocyclization/cross coupling reaction to afford 2,3,4-trifunctionalized 2,5-dihydrofurans **219** from two different α -allenols was developed by Alcaide *et al.* (Scheme 99).⁹¹ The reaction showed a high regio- and stereoselectivity, moreover it was extended to optically active substrates as well as to highly sterically demand molecules such as tertiary α -allenols. The supposed mechanism seemed to involve a palladium(II) intramolecular oxopalladation of the free allenol component, which was cross coupled with the allenic ester partner. The cycle was ended with a *trans*- β -deacyloxypalladation with the concomitant regeneration of the Pd(II) species.

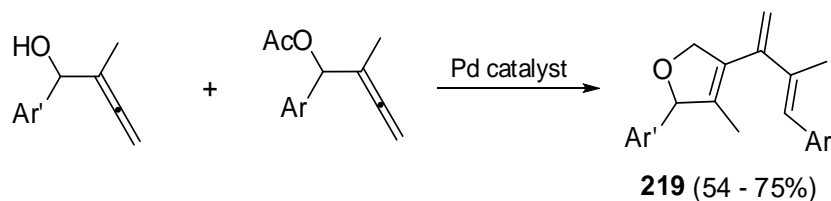

Scheme 99. Pd(II) catalyzed heterocyclization/cross coupling reaction

2,5-Dihydro-1-pyrroles or 1,2,3,6-tetrahydropyridines **221** in good yields via the one pot palladium catalyzed coupling cyclization of α - or β -amino allenes **220** with allylic halides were prepared by Ma and co-workers. The starting materials were easily available. It was believed that this

transformation most likely occurred via a Pd (II) mechanism, although a Pd (0) pathway could not be excluded (Scheme 100).⁹²

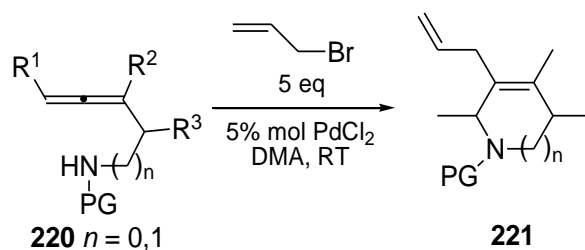

Scheme 100. One pot palladium catalyzed coupling cyclization of α - or β -amino allenes

The intramolecular reaction of allyl-palladium complexes of pyridine derivatives was exploited by Pfeffer et al to obtain a series of new cationic heterocyclic compounds **222** as indicated in Scheme 101. The reaction showed to be regioselective with the respect to the structures of the starting material. The process was successfully applied to a novel synthesis of berberiniums, a class of molecules of pharmacological interest.⁹³

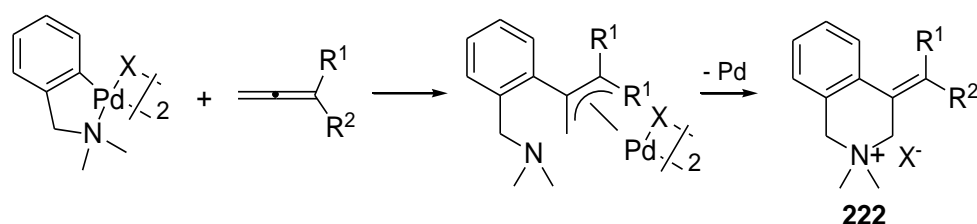

Scheme 101. Reaction of allyl-palladium complexes of pyridine derivatives

Allenes were used as carbon nucleophiles in palladium – catalyzed reactions by Bäckwall and co-workers (Scheme 102).⁹⁴ A stereochemical approach was investigated, in which the allene attacked a (π allyl)-palladium complex with electron-withdrawing ligands from the face opposite to that of palladium.

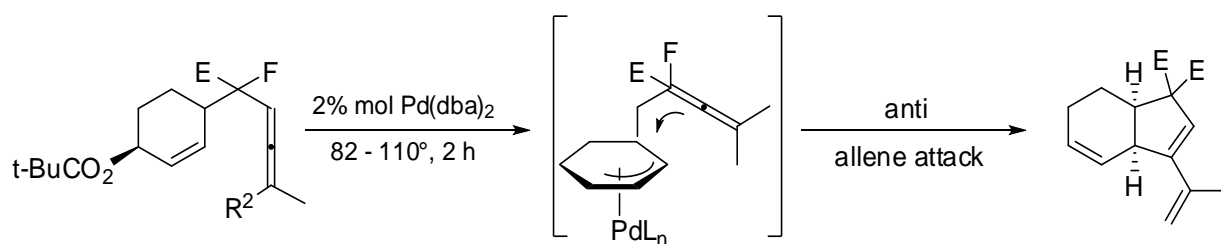

Scheme 102. Allenes as carbon nucleophiles in palladium-catalyzed reactions

Finally an example of oxapalladacycles immobilized on polystyrene-divinylbenzene **223** supports was reported by the Lu research group (Scheme 103). It was treated with 3-aryl-2-propynoates or 1-alkyl-1,2-propadienes to afford 2*H* 1-benzopyrans **224**. The yields reported were superior to those obtained for solution-phase experiments.⁹⁵

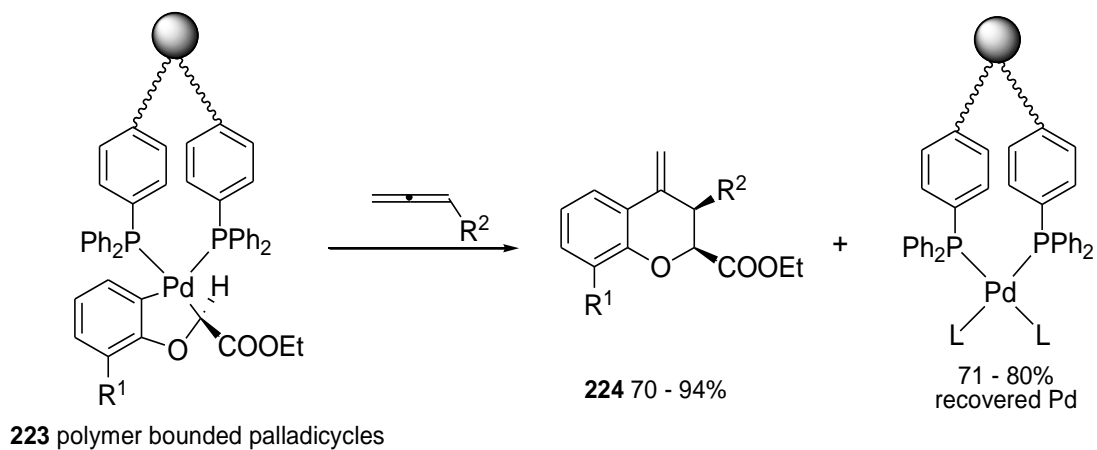

Scheme 103. Example of oxapalladacycles immobilized coupling with allenes

References

1. Zhang, W.X.; Xi, Z. 1-lithio-1,3-dienes as useful building blocks in organic synthesis. *Pure Appl. Chem.*, **2009**, *81*, 235-246.
2. Fang, H. Y.; Song, Q. L.; Wang, Z. H.; Xi, Z. F. Concise synthesis of stereodefined dienols and cyclopentadienes via direct addition of 1-bromomagnesiobutadienes and 1-lithiobutadienes to carbonyl compounds. *Tetrahedron Lett.*, **2004**, *45*, 5159-5162.
3. Song, Q. L.; Li, Z. P.; Chen, J. L.; Wang, C. Y.; Xi, Z. F. Acyl-lithiation of olefins: Formation of cyclopentenones from 1-lithio-butadienes and CO. *Org. Lett.*, **2002**, *4*, 4627-4629.
4. Schlosser, M. The activation of organolithium reagents. *J. Organomet. Chem.*, **1967**, *8*, 9-16.
5. Venturello, P. Reactivity of α,β -unsaturated acetals with electrophiles in the presence of organolithium potassium reagents. *J. Chem. Soc., Chem. Commun.*, **1992**, 1032-1033.
6. Deagostino, A.; Prandi, C.; Zavattaro, C.; Venturello, P. Functionalized 1-alkoxy-1,3-dienes: Their preparation and applications in synthetic organic. *Eur. J. Org. Chem.*, **2006**, 2463-2483.
7. Deagostino, A.; Prandi, C.; Venturello, P. α,β -unsaturated acetals in synthesis. *Curr. Org. Chem.*, **2003**, *7*, 821-839.
8. Blangetti, M.; Deagostino, A.; Prandi, C.; Zavattaro, C.; Venturello, P. N-Metalated imines by reaction of 1,1-diethoxybut-2-ene with aromatic nitriles, as useful intermediates for the synthesis of substituted pyrimidines and cyclopentenones. *Chem. Commun.*, **2008**, *14*, 1689-1691.
9. Feuerstein, M.; Chahen, L.; Doucet, H.; Santelli, M. Efficient synthesis of enynes by tetrphosphine-palladium-catalysed reaction of vinyl bromides with terminal alkynes. *Tetrahedron*, **2006**, *62*, 112-120.
10. Fang, X. N.; Jiang, M. H.; Hu, R. H.; Cai, M. Z. Facile Stereoselective Synthesis of (E)-1-Arylseleno-Substituted 1,3-Enynes and Their Applications in Synthesis of (E)-Enediynes. *Synth. Commun.*, **2008**, *38*, 4170-4181.
11. Gu, X. X.; Xie, M. H.; Zhao, X. Y.; Sun, Y.; Zhang, W.; Xie, F. D.; Wang, S. W. An efficient synthesis of polysubstituted 1,3-enynes from (E)- β -iodovinyl sulfones and terminal alkynes. *Chin. J. Chem.*, **2008**, *26*, 1625-1629.
12. Chen, J. J.; Liu, Y. H. Dialkyltitanium-mediated titanation of conjugated 1,3-butadiynes and its coupling reactions with aldehydes: a facile synthesis of stereodefined enynes and trans-enynols. *Tetrahedron Lett.*, **2008**, *49*, 6655-6658.
13. Liu, Y.; Nishiura, M.; Wang, Y.; Hou, Z. M. π -Conjugated aromatic enynes as a single-emitting component for white electroluminescence. *J. Amer. Chem. Soc.*, **2006**, *128*, 5592-5593.
14. Zhang, W. X.; Nishiura, M.; Hou, Z. M. Synthesis of (Z)-1-Aza-1,3-enynes by the Cross-Coupling of Terminal Alkynes with Isocyanides Catalyzed by Rare-Earth Metal Complexes. *Angew. Chem., Int. Ed. Engl.*, **2008**, *47*, 9700-9703.
15. Lu, J. M.; Shi, M. LDA-mediated selective addition reaction of vinylidenecyclopropanes with aldehydes, ketones, and enones: Facile synthesis of vinylcyclopropenes, allenols, and 1,3-enynes. *Organic Lett.*, **2008**, *10*, 1943-1946.
16. Watanabe, M.; Nakamura, M.; Satoh, T. Reaction of magnesium alkylidene carbenoids with lithium acetylides and lithium thiolates: a novel synthesis of conjugated enynes and vinyl sulfides. *Tetrahedron*, **2005**, *61*, 4409-4418.
17. Blangetti, M.; Deagostino, A.; Rosso, H.; Prandi, C.; Zavattaro, C.; Venturello, P. Rapid and easy access to (E)-1,3-enynes, 1,3-diyne and allenes starting from propargylic acetals, exploiting the different reactivity of lithium and mixed lithium-potassium organometallic reagents. *Eur. J. Org. Chem.*, **2007**, 5867-5874.
18. Chen, C. W.; Luh, T. Y. Elimination of β -Thioalkoxy Alcohols under Mitsunobu Conditions. A New Synthesis of Conjugated Enynes from Propargylic Dithioacetals. *J. Org. Chem.*, **2008**, *73*, 8357-8363.
19. Miller, K. M.; Colby, E. A.; Woodin, K. S.; Jamison, T. F. Asymmetric catalytic reductive coupling of 1,3-enynes and aromatic aldehydes. *Adv. Synth. Catal.*, **2005**, *347*, 1533-1536.
20. Komanduri, V.; Krische, M. J. Enantioselective reductive coupling of 1,3-enynes to heterocyclic aromatic aldehydes and ketones via rhodium-catalyzed asymmetric hydrogenation: Mechanistic insight into the role of Bronsted acid additives. *J. Am. Chem. Soc.*, **2006**, *128*, 16448-16449.
21. Zhao, Y. L.; Chen, L.; Liu, Q.; Li, D. W. Stereoselective C-C bond-forming reaction of α -ethynyl ketene-S,S-acetals with aldehydes in the presence of titanium tetrahalides. *Synlett*, **2007**, *1*, 37-42.
22. Luken, C.; Moberg, C. Silaborations of 1,3-enynes - Substrate controlled allene/1,3-diene selectively. *Org. Lett.*, **2008**, *10*, 2505-2508.
23. Ma, S. M.; He, Q. W.; Jin, X. Tunable 1,3-lithium shift of propargylic/allenylic lithiums formed by conjugate addition of 4-aryl-3-butyn-1-enes with organolithiums and the subsequent transmetalation/Pd(O)-catalyzed coupling reaction with aryl halides. *Synlett*, **2005**, *3*, 514-516.
24. Waser, J.; Gonzalez-Gomez, J. C.; Nambu, H.; Huber, P.; Carreira, E. M. Cobalt-catalyzed hydrohydrazination of dienes and enynes: Access to allylic and propargylic hydrazides. *Org. Lett.*, **2005**, *7*, 4249-4252.

25. Deagostino, A.; Farina, V.; Prandi, C.; Zavattaro, C.; Venturello, P. New metal-catalyzed synthesis of quinoline and chromene skeletons. *Eur. J. Org. Chem.*, **2006**, *15*, 3451-3456.
26. Bolos, J.; Loscertales, T.; Nieto, J.; Sacristan, A.; Ortiz, J. A. A new efficient synthesis of 3-(hydroxymethyl)-4H-chromen-4-ones. *J. Heterocycl. Chem.*, **2000**, *37*, 1203-1208.
27. Gunduz, C.; Salan, U.; Ozkul, N.; Basaran, I.; Cakir, U.; Bulut, M. The synthesis and complexation study of some novel 3-methoxyphenyl chromenone crown ethers using conductometry. *Dyes Pigm.*, **2006**, *71*, 161-167.
28. Murr, M. D. E.; Cano, C.; Golding, B. T.; Hardcastle, I. R.; Hummersome, M.; Frigerio, M.; Curtin, N. J.; Menear, K.; Richardson, C.; Smith, G. C. M.; Griffin, R. J. 8-biarylchromen-4-one inhibitors of the DNA-dependent protein kinase (DNA-PK). *Bioorg. Med. Chem. Lett.*, **2008**, *18*, 4885-4890.
29. Rueping, M.; Merino, E.; Sugiono, E. Enantioselective organocatalytic reactions of 4-hydroxycoumarin and 4-hydroxypyron with α,α -unsaturated aldehydes - An efficient Michael addition-acetalization cascade to chromenones, quinolinones and pyranones. *Adv. Synth. Catal.*, **2008**, *350*, 2127-2131.
30. Marull, M.; Schlosser, M. Selective and efficient structural elaboration of 2-(trifluoromethyl)quinolinones. *Eur. J. Org. Chem.*, **2003**, *8*, 1576-1588.
31. Lefebvre, O.; Marull, M.; Schlosser, M. 4-(trifluoromethyl)quinoline derivatives. *Eur. J. Org. Chem.*, **2003**, *11*, 2115-2121.
32. Hessian, K. O.; Flynn, B. L. Iodine-induced reaction cascades for the rapid construction of variously substituted benzothiophenes. *Org. Lett.*, **2003**, *5*, 4377-4380.
33. Yue, D.; Larock, R. C. Synthesis of 2,3-disubstituted benzo[b]thiophenes via palladium-catalyzed coupling and electrophilic cyclization of terminal acetylenes. *J. Org. Chem.*, **2002**, *67*, 1905-1909.
34. Flynn, B. L.; Verdier-Pinard, P.; Hamel, E. A novel palladium-mediated coupling approach to 2,3-disubstituted benzo[b]thiophenes and its application to the synthesis of tubulin binding agents. *Org. Lett.*, **2001**, *3*, 651-654.
35. Hessian, K. O.; Flynn, B. L. Selective endo and exo iodocyclizations in the synthesis of Quinolines and Indoles. *Org. Lett.*, **2006**, *8*, 243-246.
36. Nadaraj, V.; Selvi, S. T.; Sasi, R. Microwave-assisted synthesis of quinoline alkaloids: 4-Methoxy-1-methyl-2-quinolinone and its analogs. *Arkivoc*, **2006**, 82-89.
37. Tu, S. J.; Jiang, B.; Zhang, J. Y.; Jia, R. H.; Zhang, Y.; Yao, C. S. Efficient and direct synthesis of poly-substituted indeno[1,2-b]quinolines assisted by p-toluene sulfonic acid using high-temperature water and microwave heating via one-pot, three-component reaction. *Org. Biomol. Chem.*, **2006**, *4*, 3980-3985.
38. Huang, C. C.; Chang, N. C. New approach to 2-quinolinones. *Org. Lett.*, **2008**, *10*, 673-676.
39. Likhar, P. R.; Subhas, M. S.; Roy, S.; Kantam, M. L.; Sridhar, B.; Seth, R. K.; Biswas, S. Synthesis of highly substituted 2-perfluoroalkyl quinolines by electrophilic iodocyclization of perfluoroalkyl propargyl imines/amines. *Org. Biomol. Chem.*, **2009**, *7*, 85-93.
40. Mamane, V.; Louerat, F.; Lehl, J.; Abboud, M.; Fort, Y. A general and efficient method for the synthesis of benzo-(iso)quinoline derivatives. *Tetrahedron*, **2008**, *64*, 10699-10705.
41. Gai, X. J.; Grigg, R.; Ramzan, M. I.; Sridharan, V.; Collard, S.; Muir, J. E. Pyrazole and benzothiazole palladacycles: stable and efficient catalysts for carbon-carbon bond formation. *Chem. Commun.*, **2000**, *20*, 2053-2054.
42. Grigg, R.; Koppen, I.; Rasparini, M.; Sridharan, V. Synthesis of spiro- and fused heterocycles by palladium catalysed carbo- and heteroannulation cascades of allenes. *Chem. Commun.*, **2001**, *11*, 964-965.
43. Brown, S.; Grigg, R.; Hinsley, J.; Korn, S.; Sridharan, V.; Uttley, M. D. Three-component Heck-Diels-Alder cascade processes involving alkylallenes, aryl iodides and dienophiles. *Tetrahedron*, **2001**, *57*, 10347-10355.
44. Grigg, R.; Martin, W.; Morris, J.; Sridharan, V. Four-component Pd-catalysed cascade/ring closing metathesis. Synthesis of heterocyclic enones. *Tetrahedron*, **2005**, *61*, 11380-11392.
45. Knoke, M.; de Meijere, A. Cyclopropyl building blocks in organic synthesis, part 85. A versatile access to 1-cyclopropyl-2-aryl-1,3,5-hexatrienes - Domino Heck-Diels-Alder reactions of 1,3-dicyclopropyl-1,2-propadiene. *Synlett*, **2003**, *2*, 195-198.
46. Inamoto, K.; Yamamoto, A.; Ohsawa, K.; Hiroya, K.; Sakamoto, T. Highly regioselective palladium-catalyzed annulation reactions of heteroatom-substituted allenes for synthesis of condensed heterocycles. *Chem. Pharm. Bull.*, **2005**, *53*, 1502-1507.
47. Lu, G. L.; Malinakova, H. C. Regio- and diastereoselective insertion of allenes into stable oxapalladacycles with a metal-bonded stereogenic carbon. Preparation of contiguously substituted 3,4-dihydro-2H-1-benzopyrans. *J. Org. Chem.*, **2004**, *69*, 8266-8279.
48. Fu, C. L.; Ma, S. M. Observation of the first Heck-type cross-coupling reaction of allenes with aryl halides. Synthesis of polysubstituted 1,2-allenyl sulfones. *Org. Lett.*, **2005**, *7*, 1605-1607.

49. Jiang, X. F.; Ma, X. J.; Zheng, Z. L.; Ma, S. Controllable Cyclization Reactions of 2-(2',3'-Allenyl)acetylacetates Catalyzed by Gold and Palladium Affording Substituted Cyclopentene and 4,5-Dihydrofuran Derivatives with Distinct Selectivity. *Chem. Eur. J.*, **2008**, *14*, 8572-8578.
50. Deagostino, A.; Prandi, C.; Toppino, A.; Venturello, P. Palladium-catalysed Heck reaction on 1,2-dien-1-ols: a stereoselective synthesis of α -arylated α,β -unsaturated aldehydes. *Tetrahedron*, **2008**, *64*, 10344-10349.
51. Deagostino, A.; Prandi, C.; Venturello, P. Palladium-catalyzed Heck reaction on 1-alkoxy-1,3-dienes: A regioselective γ -arylation of α,β -unsaturated carbonyl compounds. *Org. Lett.*, **2003**, *5*, 3815-3817.
52. Beccaria, L.; Deagostino, A.; Prandi, C.; Zavattaro, C.; Venturello, P. Heck Reaction on 1-Alkoxy-1,3-dienes in Ionic Liquids: A Superior Medium for the Regioselective Arylation of the Conjugated Dienic System. *Synlett*, **2006**, *18*, 2989-2992.
53. Chen, Q.; Li, C. Activation of the Vinylic C-Cl Bond by Complexation of $\text{Fe}(\text{CO})_3$: Palladium-Catalyzed Coupling Reactions of (η^4 -Chlorodiene)tricarbonyliron Complexes. *Organometallics*, **2007**, *26*, 223-229.
54. Wang, Y.; Burton, D. J. Base-catalyzed cyclization of monofluorodienynes: a new route to substituted fluorobenzene derivatives. *Tetrahedron Lett.*, **2006**, *47*, 9279-9281.
55. Tang, C. J.; Wu, Y. K. On the synthesis of cepacin A. *Tetrahedron*, **2007**, *63*, 4887-4906.
56. Denmark, S. E.; Tymonko, S. A. Sequential Cross-Coupling of 1,4-Bissilylbutadienes: Synthesis of Unsymmetrical 1,4-Disubstituted 1,3-Butadienes. *J. Amer. Chem. Soc.*, **2005**, *127*, 8004-8005.
57. Huang, T. H.; Chang, H. M.; Wu, M. Y.; Cheng, C. H. Palladium-catalyzed three-component assembling of allenes, organic halides, and arylboronic acids. *J. Org. Chem.*, **2002**, *67*, 99-105.
58. Ma, S. M.; Jiao, N.; Ye, L. W. Palladium-catalyzed highly regio- and stereoselective addition of organoboronic acids to allenes in the presence of AcOH. *Chem. Eur. J.*, **2003**, *9*, 6049-6056.
59. Zhu, G. G.; Zhang, Z. G. Palladium-catalyzed tandem cyclization/suzuki coupling reaction of 1, 2,7-trienes. *Org. Lett.*, **2004**, *6*, 4041-4044.
60. Tonogaki, K.; Itami, K.; Yoshida, J. Catalytic four-component assembly based on allenylboronate platform: New access to privileged allylic amine structures. *J. Amer. Chem. Soc.*, **2006**, *128*, 1464-1465.
61. Woodward, A. R.; Burks, H. E.; Chan, L. M.; Morken, J. P. Concatenated catalytic asymmetric allene diboration/allylation/functionalization. *Org. Lett.*, **2005**, *7*, 5505-5507.
62. Balma Tivola, P.; Deagostino, A.; Prandi, C.; Venturello, P. A new synthesis of butadienyl- and styrylboronic esters: highly reactive intermediates for Suzuki cross-coupling. *Org. Lett.*, **2002**, *4*, 1275-1277.
63. Deagostino, A.; Migliardi, M.; Occhiato, E. G.; Prandi, C.; Zavattaro, C.; Venturello, P. LIC-KOR promoted formation of conjugated dienes as useful building blocks for palladium-catalyzed syntheses. *Tetrahedron*, **2005**, *61*, 3429-3436.
64. Shimizu, M.; Kurahashi, T.; Shimono, K.; Tanaka, K.; Nagao, I.; Kiyomoto, S.; Hiyama, T. Facile Synthesis and Palladium-Catalyzed Cross-Coupling Reactions of 2,3-Bis(pinacolatoboryl)-1,3-butadiene. *Chem. Asian J.*, **2007**, *2*, 1400-1408.
65. Shimizu, M.; Shimono, K.; Schelper, M.; Hiyama, T. Stereoselective Cross-coupling Reaction of 2,4-Diaryl-1,1-diboryl-1,3-butadienes: Stereocontrolled Approach to 1,3,4,6-Tetraarylated 1,3,5-Hexatrienes. *Synlett*, **2007**, *12*, 1969-1971.
66. Kurahashi, T.; Hata, T.; Masai, H.; Kitagawa, H.; Shimizu, M.; Hiyama, T. Geminal dimetalation of alkylidene-type carbenoids with silylboranes and diborons. *Tetrahedron*, **2002**, *58*, 6381-6395.
67. Hata, T.; Kitagawa, H.; Masai, H.; Kurahashi, T.; Shimizu, M.; Hiyama, T. Geminal Difunctionalization of Alkenylidene-Type Carbenoids by Using Interelement Compounds. *Angew. Chem., Int. Ed. Engl.*, **2001**, *40*, 790-792.
68. Babudri, F.; Farinola, G. M.; Naso, F.; Ragni, R.; Spina, G. A Novel Stereoselective Synthesis of Symmetrical (1E,3E)-1,4-Diarylbuta-1,3-dienes. *Synthesis*, **2007**, *19*, 3088-3092.
69. Morita, R.; Shirakawa, E.; Tsuchimoto, T.; Kawakami, Y. Synthesis of multisubstituted 1,3-butadienes using the ruthenium-catalysed double addition of trimethylsilyldiazomethane to alkynylboronates. *Org. Biomol. Chem.*, **2005**, *3*, 1263-1268.
70. Lopez, S.; Montenegro, J.; Saa, C. Highly Convergent, Stereospecific Synthesis of 11-cis-Retinoids by Metal-Catalyzed Cross-Coupling Reactions of (Z)-1-Alkenylmetals. *J. Org. Chem.* **2007**, *72*, 9572-9581.
71. Ohmura, T.; Yamamoto, Y.; Miyaura, N. Rhodium- or Iridium-Catalyzed trans-Hydroboration of Terminal Alkynes, Giving (Z)-1-Alkenylboron Compounds. *J. Amer. Chem. Soc.*, **2000**, *122*, 4990-4991.
72. Uenishi, J.; Beau, J. M.; Armstrong, R. W.; Kishi, Y. Dramatic rate enhancement of Suzuki diene synthesis. Its application to palytoxin synthesis. *J. Amer. Chem. Soc.*, **1987**, *109*, 4756-4758.
73. Rousset, S.; Abarbri, M.; Thibonnet, J.; Duchene, A.; Parrain, J. L. Palladium-catalysed annulation reaction of allenyltins with β -iodo vinylic acids: selective synthesis of α -pyrones. *Chem. Commun.*, **2000**, *20*, 1987-1988.

74. Cherry, K.; Duchene, A.; Thibonnet, J.; Parrain, J. L.; Abarbri, M. Regioselective synthesis of 1,4,6-trisubstituted-2-pyridinones and 2,3-disubstituted (2H)-isoquinolin-1-ones via tandem Stille reaction/heterocyclisation. *Synthesis*, **2005**, *14*, 2349-2356.
75. Huang, C. W.; Shanmugasundaram, M.; Chang, H. M.; Cheng, C. H. Highly chemoselective coupling of allenylstannanes with organic iodides promoted by Pd(PPh₃)₄/LiCl: an efficient method for the synthesis of substituted allenes. *Tetrahedron*, **2003**, *59*, 3635-3641.
76. Lavecchia, G.; Berteina-Raboin, S.; Guillaumet, G. Selective bifunctionalization of pyrido[2,3-d]pyrimidines in positions 2 and 4 by SNAr and palladium-catalyzed coupling reactions. *Tetrahedron Lett.*, **2005**, *46*, 5851-5855.
77. Mukai, C.; Takahashi, Y. A new entry to the synthesis of 2,3-disubstituted indoles. *Org. Lett.*, **2005**, *7*, 5793-5796.
78. Hodgson, D. M.; Chung, Y. K.; Nuzzo, I.; Freixas, G.; Kulikiewicz, K. K.; Cleator, E.; Paris, J. M. Intramolecular cyclopropanation of unsaturated terminal epoxides and chlorohydrins. *J. Amer. Chem. Soc.* **2007**, *129*, 4456-4462.
79. Trostyanskaya, I. G.; Maslova, E. N.; Kazankova, M. A.; Beletskaya, I. P. Transition metal-catalyzed cross-coupling of 1,4-diiodobutadienes with thiols—A novel route to 1,4-bis(R-sulfanyl)buta-1,3-dienes. *Russ. J. Org. Chem.*, **2008**, *44*, 24-30.
80. Ogasawara, M.; Okada, A.; Watanabe, S.; Fan, L.; Uetake, K.; Nakajima, K.; Takahashi, T. Synthesis, Structure, and Reactivity of (1,2,3- λ^3 -Butadien-3-yl)palladium Complexes. *Organometallics*, **2007**, *26*, 5025-5029.
81. Barluenga, J.; Aznar, F.; Moriel, P.; Valdés, C. Palladium-Catalyzed Amination of 1-Bromo- and 1-Chloro-1,3-butadienes: A General Method for the Synthesis of 1-Amino-1,3-butadienes. *Adv. Synth. Catal.*, **2004**, *346*, 1697-1701.
82. Shi, Y.; Ramgren, S. D.; Blum, S. A. Palladium-Catalyzed Carboauration of Alkynes and Palladium/Gold Cross-Coupling. *Organometallics*, **2009**, *28*, 1275-1277.
83. Leitner, A.; Larsen, J.; Steffens, C.; Hartwig, J. F. Palladium-Catalyzed Addition of Mono- and Dicarboxyl Compounds to Conjugated Dienes. *J. Org. Chem.* **2004**, *69*, 7552-7557.
84. Gulias, M.; Duran, J.; Lopez, F.; Castedo, L.; Mascarenas, J. L. Palladium-Catalyzed [4 + 3] Intramolecular Cycloaddition of Alkylidenecyclopropanes and Dienes. *J. Amer. Chem. Soc.*, **2007**, *129*, 11026-11027.
85. Chang, K. J.; Rayabarapu, D. K.; Yang, F. Y.; Cheng, C. H. Unusual palladium-catalyzed silaboration of allenes using organic iodides as initiators: Mechanism and application. *J. Amer. Chem. Soc.*, **2005**, *127*, 126-131.
86. Ohmura, T.; Taniguchi, H.; Suginome, M. J. Palladium-catalyzed asymmetric silaboration of allenes. *Amer. Chem. Soc.*, **2006**, *128*, 13682-13683.
87. Hong, Y. T.; Yoon, S. K.; Kang, S. K.; Yu, C. M. A stereoselective carbocyclization of bis(allenes) with germylstannane catalyzed by palladium complexes. *Eur. J. Org. Chem.*, **2004**, *22*, 4628-4635.
88. Toyofuku, M.; Murase, E.; Fujiwara, S.; Shin-ike, T.; Kuniyasu, H.; Kambe, N. Palladium-catalyzed selenoacylation of allenes leading to the regioselective formation of functionalized allyl selenides. *Org. Lett.*, **2008**, *10*, 3957-3960.
89. Patil, N. T.; Pahadi, N. K.; Yamamoto, Y. An improved catalytic system, Pd(PPh₃)₄/PhCOOH combined catalyst, for the allylation of carbon pronucleophiles with allenes. *Synthesis*, **2004**, *13*, 2186-2190.
90. Trost, B. M.; Simas, A. B. C.; Plietker, B.; Jakel, C.; Xie, J. Enantioselective palladium-catalyzed addition of 1,3-dicarbonyl compounds to an allene derivative. *Chem. Eur. J.*, **2005**, *11*, 7075-7082.
91. Alcaide, B.; Almendros, P.; del Campo, T. M. Reaction of two different α -allenols in a heterocyclization/cross-coupling sequence: Convenient access to functionalized buta-1,3-dienyl dihydrofurans. *Angew Chem., Int. Ed. Engl.*, **2006**, *45*, 4501-4504.
92. Ma, S. M.; Yu, F.; Gao, W. Z. Studies on Pd(II)-catalyzed coupling-cyclization of α - or β -amino allenes with allylic halides. *J. Org. Chem.*, **2003**, *68*, 5943-5949.
93. Chengebroyen, J.; Linke, M.; Robitzer, M.; Sirlin, C.; Pfeffer, M. Palladium-mediated intramolecular C-N bond formation involving allyl substituted pyridines. Application to a novel strategy for the synthesis of the skeleton of berberinium derivatives. *J. Organomet. Chem.*, **2003**, *687*, 313-321.
94. Franzen, J.; Lofstedt, J.; Dorange, I.; Backvall, J. E. Allenes as carbon nucleophiles in palladium-catalyzed reactions: Observation of anti attack of allenes on (π -allyl)palladium complexes. *J. Amer. Chem. Soc.*, **2002**, *124*, 11246-11247.
95. Hershberger, J. C.; Zhang, L.; Lu, G. L.; Malinakova, H. C. Polymer-supported palladacycles: Efficient reagents for synthesis of Benzopyrans with palladium recovery. Relationship among resin loading, Pd: P ratio, and reactivity of immobilized palladacycles. *J. Org. Chem.*, **2006**, *71*, 231-235.